

PER4MER

QUAD PERFORMANCE FX UNIT

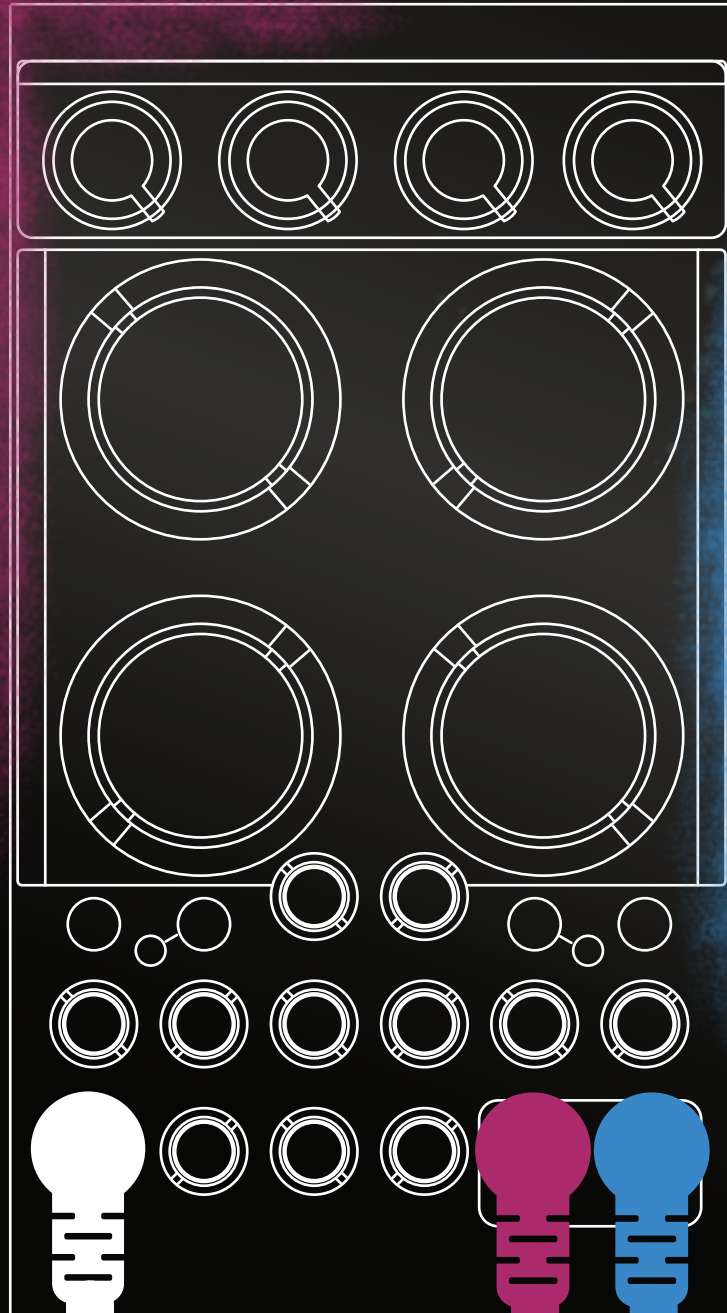





Contents

About Us	1
Overview	3
Manual Control	13
External Control	23
System	29



About Us

MODBAP MODULAR BY BEATPPL

Modbap Modular is a line of eurorack modular synthesizers and electronic music instruments by Beatppl. Founded by Corry Banks (Bboytech), Modbap Modular was born of the Modbap Movement with a simple mission to dev tools for beat driven hiphop leaning modular artists. It is our goal to develop eurorack modules from the beatmaker's perspective while adding value for music makers of all genres.

It's almost impossible to explain Modbap Modular without answering the questions; "So, what is ModBap?" MODBAP is the fusion of modular synthesis and boom-bap (or any form of hiphop) music production. The term was created by BBoyTech as a denotation of his experiments with modular synthesis and boombap music production. From that point forward, a movement was born where like minded creatives built a community around idea of Modbap. Modbap Modular is in effect, the result of that movement in a space where we'd previously not existed.

**BUILT FOR EURORACK
DOPE ENOUGH FOR BOOMBAP!**

www.modbap.com





Overview

PER4MER

Per4mer is a quad performance FX module consisting of delay, reverb, glitch and tape stop effects triggered by the four dedicated arcade buttons which can be manually operated or triggered from external gate inputs. Each effect has a set of FX parameters that can be controlled using the four rotary knobs or by the CV inputs. Compression and color processing effects are featured along with sidechain and tap tempo options. External sidechain and clock can be connected to interface with other gear. Per4mer packs a punch in a 14HP stereo FX eurorack module form and is inspired by beatmaker/DJ performance styles. Per4mer makes quick, fun, and easy work of engaging and performing with smooth no click action arcade buttons.

WHAT'S IN THE BOX?

The Per4mer package comes with the following items included:-

- Per4mer module.
- Eurorack IDC power ribbon cable
- 4 x 3m mounting screws.
- Sticker.

SPECIFICATION AND CORE FEATURES

- Module size. 3U, 14 HP, Depth 25mm
- +12V current demand 50mA.
- -12V current demand 50mA
- +5V current demand 0mA
- 4 Arcade buttons rated at 10 million presses.
- 4 knobs
- 4 performance effects (delay, reverb, glitch and tape stop)
- 2 processing effects (compression and color)
- 4 fixed color presets (classic, lofi, saturation and wax)
- Side chain input
- Tap tempo
- CV control over the FX knobs
- Gate inputs for triggering and engaging the arcade FX buttons
- Reverse polarity protection on the power input.

INSTALLATION

Follow the installation instructions carefully to avoid module or rack damage.

1. Ensure the power connection is disconnected before installing the device.
2. Identify a location in the rack to install the module. This needs 14HP of free space.
3. Connect the 10 pin connector from the IDC ribbon power cable to the header on the rear side of the module. Ensure that the pins are aligned correctly with the red stripe on the ribbon conductor closest to the -12V pin on the header.
4. Insert the cable through the rack and connect the 16 pin side of the IDC ribbon cable to the rack power supply header. Ensure that the pins are aligned correctly with the red stripe on the ribbon conductor closest to the -12V pin on the header.
5. Mount and position the module into the dedicated rack position.
6. Attach the 4 x M3 screws by screwing into the 4 locator holes and the rack mount. Do not over tighten.
7. Power up the rack and observe the module start up.

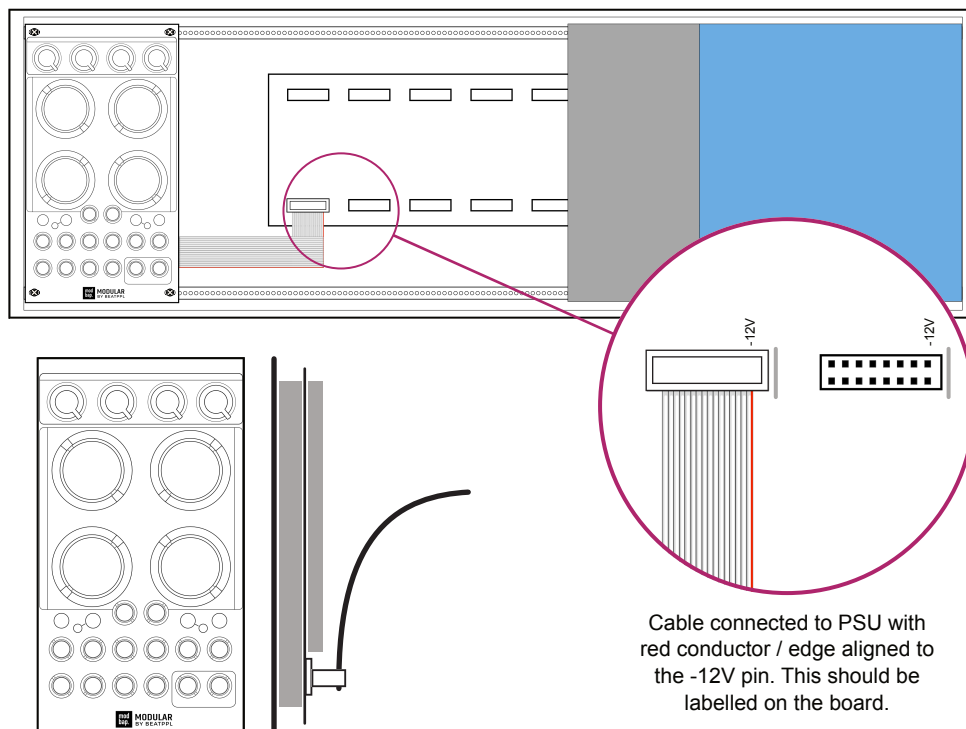

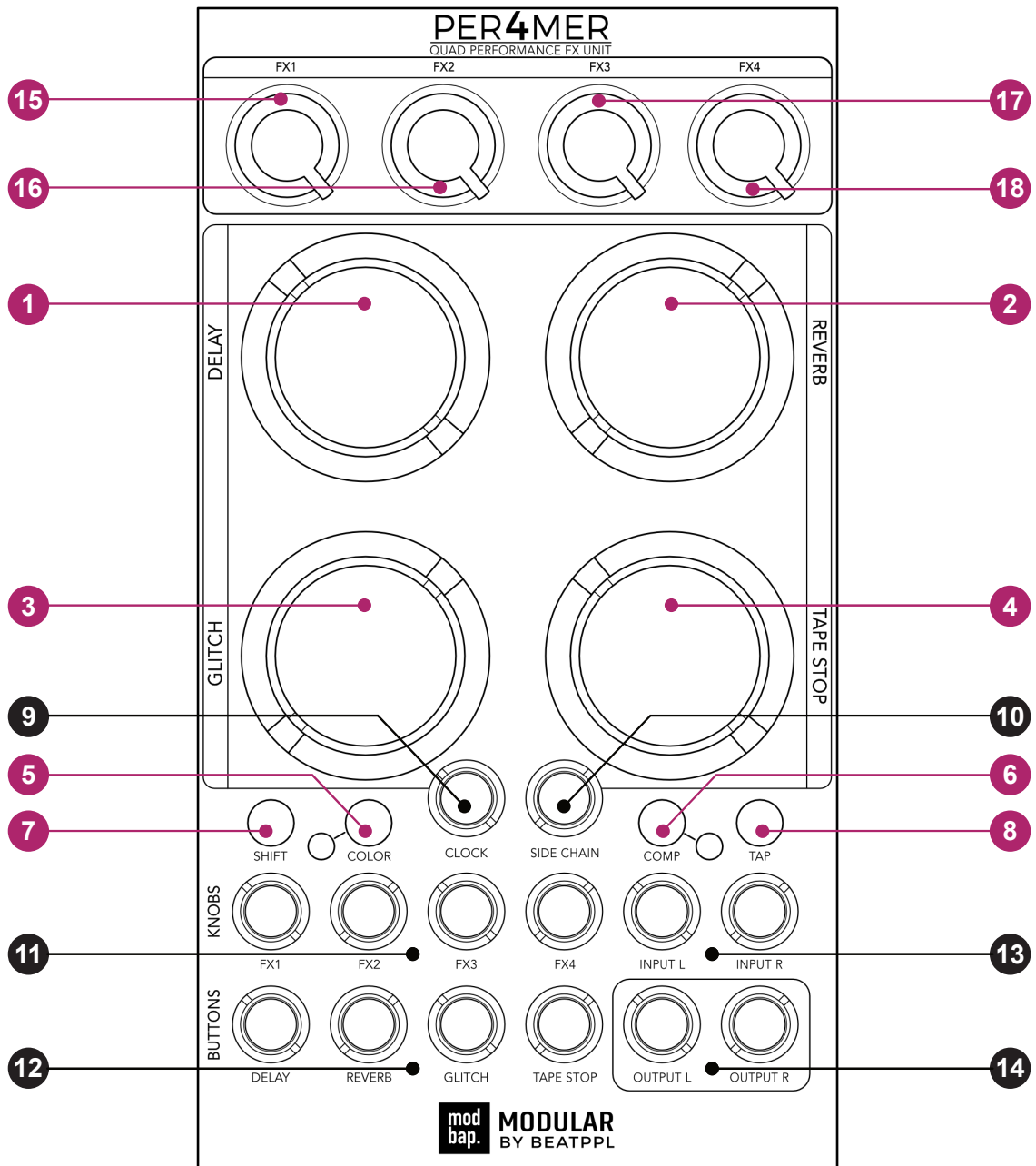

Press or Turn

Plug and Patch

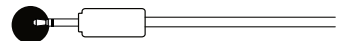

- 1 Delay performance effect selection arcade activation button.
- 2 Reverb performance effect selection arcade activation button.
- 3 Glitch performance effect selection arcade activation button.
- 4 Tape stop performance effect selection arcade activation button.

- 5 Color selection button. Four fixed presets with LED selection indicator.
- 6 Compressor selection button.
- 7 Shift button. Access to secondary functions.
- 8 Tap tempo button. Tap several times to register an internal tempo BPM.

- 9 Clock input. External clock
- 10 Sidechain CV input for compressor.

- 11 CV Inputs. Control the FX by CV Targeting which locks the CV input to the effect.
- 12 Gate Inputs. Activates each of the performance effects.
- 13 Audio Left / Right Inputs
- 14 Audio Left / Right Outputs.

- 15 FX1 - Function is dependant on the selected performance effect.
- 16 FX2 - Function is dependant on the selected performance effect.
- 17 FX3- Function is dependant on the selected performance effect.
- 18 FX4 - Function is dependant on the selected performance effect.

PERFORMANCE EFFECTS

DELAY

1

FX1 - Wet / Dry	FX2 - Time	FX3 - Feedback	FX4 - Filter Cutoff
Mix between the original dry signal and the effect when delay mode is active.	Adjusts the delay time when delay mode is active.	Adjusts the delay feedback amount when delay is active.	Feedback delay. Low pass filter left of rotary (0-50%) and high pass on the right of rotary (>50%)
SHIFT + FX1 - Attack Adjusts the attack time of the delay envelope between 5ms - 5sec	SHIFT + FX2 - Release Adjusts the release time of the delay envelope between 5ms - 5sec		

REVERB

2

FX1 - Wet / Dry	FX2 - Time	FX3 - Decay	FX4 - Pre-delay
Mix between the original dry signal and the effect when reverb mode is active.	Adjusts the reverb time when reverb mode is active.	Adjusts the reverb decay time when reverb is active.	Adjusts the reverb pre-delay time when reverb is active.
SHIFT + FX1 - Attack Adjusts the attack time of the reverb envelope between 5ms - 5sec	SHIFT + FX2 - Release Adjusts the release time of the reverb envelope between 5ms - 5sec		

GLITCH

3

FX1 - Wet / Dry	FX2 - Size	FX3 - Pitch	FX4 - Reverse
Mix between the original dry signal and the effect when glitch mode is active.	Adjusts the time division of the repeated slice when glitch mode is active.	Adjusts the pitch +/- 2 octaves, centre neutral when in glitch mode.	Changes between forward (normal) - rotary position <50% and reversed audio - rotary position >50%.
SHIFT + FX1 - Attack Adjusts the attack time of the glitch envelope between 5ms - 5sec	SHIFT + FX2 - Release Adjusts the release time of the glitch envelope between 5ms - 5sec		

TAPE STOP

4

FX1 - Wet / Dry	FX2 - Time	FX3 - Slope	FX4 - Filter
Mix between the original dry signal and the effect when tape stop mode is active.	Adjusts the tape speed and pitch rate when tape stop is active.	Adjusts the shape of the tape stop curve. Sweeps from exponential to cubic.	Adjusts the low pass filter cutoff frequency for tape stop.
SHIFT + FX1 - Attack Adjusts the attack time of the tape stop envelope between 5ms - 5sec	SHIFT + FX2 - Release Adjusts the release time of the tape stop envelope between 5ms - 5sec		

PROCESSING EFFECTS

COLOR 5

Press COLOR to select on and off and SHIFT + COLOR to cycle presets

Classic - Preset 1	LoFi - Preset 2	Saturation - Preset 3	Wax - Preset 4
Classic mode. Classic 12-bit reduction, 16kHz sample rate.	LoFi Mode. Dirty 8-bit reduction, 6kHz sample rate.	Saturation. Introduces soft clipping and rolls off highs to create warmth. Adds punch and mid-low boost.	Wax. Adds noise, clicks, warble and hiss and delivers a dusty vibe reminiscent of vinyl.
Purple LED indicator	Teal LED indicator	Orange LED indicator	Blue LED indicator

Hold COLOR button for >2 Seconds to select CV Targeting mode. This allows the arcade buttons to then select which effect is locked to the incoming CV controls.

COMPRESSOR 6

Press COMP + Turn the FX rotary for the desired compressor setting.

FX1 - Threshold	FX2 - Ratio	FX3 - Attack Time	FX4 - Release Time
Compressor threshold level when in compressor mode.	Sets the compressor ratio 2:1, 3:1, 4:1, 8:1 12:1 when in compressor mode.	Adjusts the compressor attack time.	Adjusts the compressor release time.

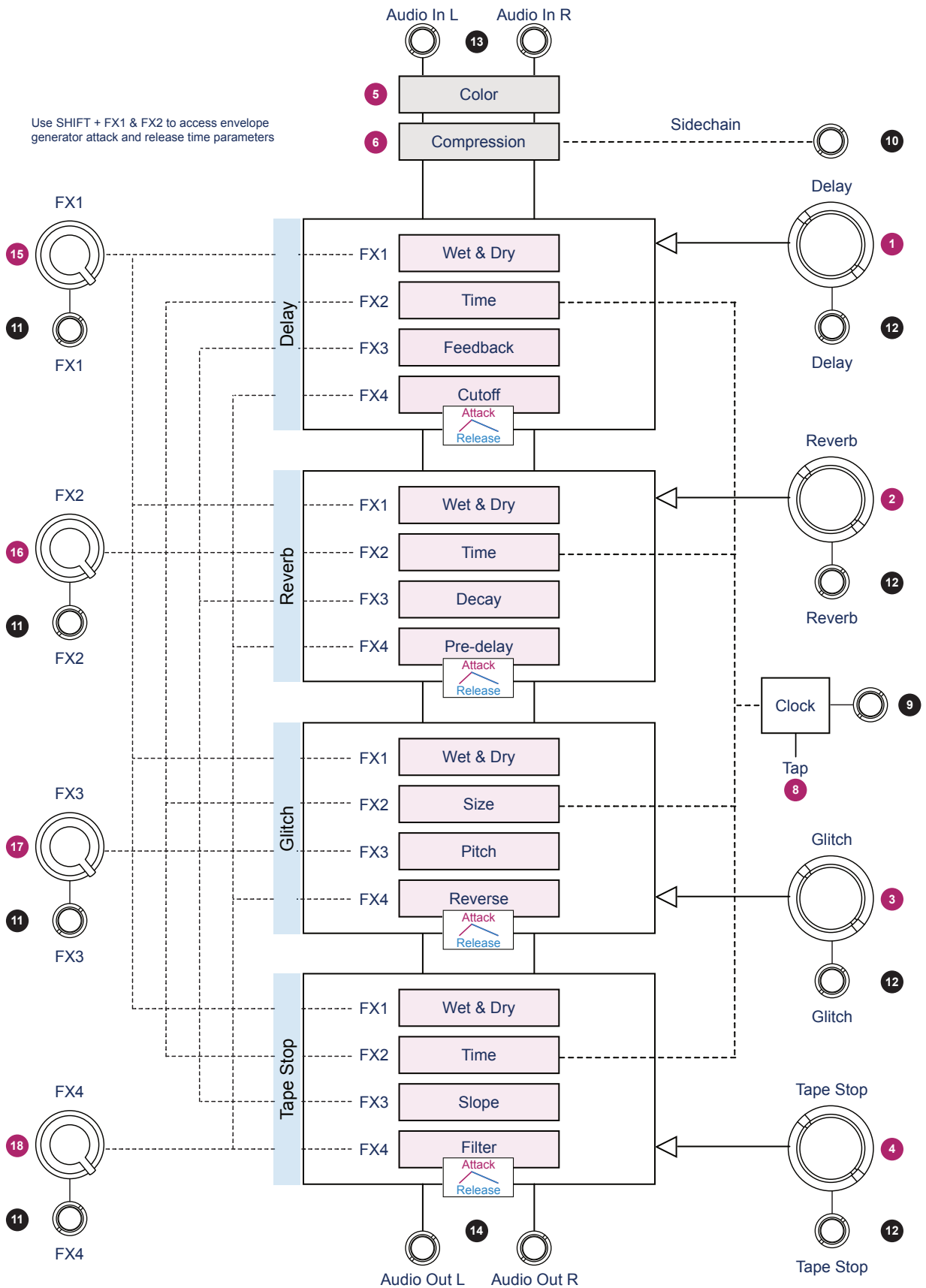

INPUT / OUTPUT ASSIGNMENT

CV and Gate are applied to the FX controls and the performance effect buttons respectively. Dual mono audio inputs and outputs are provided.

	Delay	Reverb	Glitch	Tape Stop
Gate	>1V	>1V	>1V	>1V
	FX1	FX2	FX3	FX4
CV	+/-5V	+/-5V	+/-5V	+/-5V

Each FX Knob is assigned the specific parameter of the last selected effect. The CV targeting can be locked to an effect by holding Shift + Color and pressing the desired effect arcade button.

	Audio L	Audio R
Input	Mono *	Mono
Output	Mono	Mono

* A single input connected to the left channel will normalise audio to the right input.



Manual Control

PER4MER

Per4mer has four performance effects which can be engaged individually or simultaneously using the large front panel arcade buttons. Four rotary knobs, FX1 - FX4 provide control over each of the four performance effects parameters. The parameter set is unique to each effect and are applied to the knobs based on the last effect selected. The design is aimed at live performance and improvisation with endless and unique on the fly sounds and rhythmic dynamics. Audio inputs and outputs are provided as mono connections paired for stereo. Per4mer not only delivers a series of great effects and sound design possibilities, but it also brings the creative, classic and well served techniques used by beat makers and DJs to be applied in the world of eurorack modular especially using the manual control options.

GETTING STARTED

The basic principle of Per4mer is to feed in an audio input and to trigger on-the-fly effects, bringing DJ style live improvisation to a modular environment. Effects can be triggered simultaneously or individually where an inspiring effect palette combines to generate unique creative beats and melodies.

Basic Operation Workflow

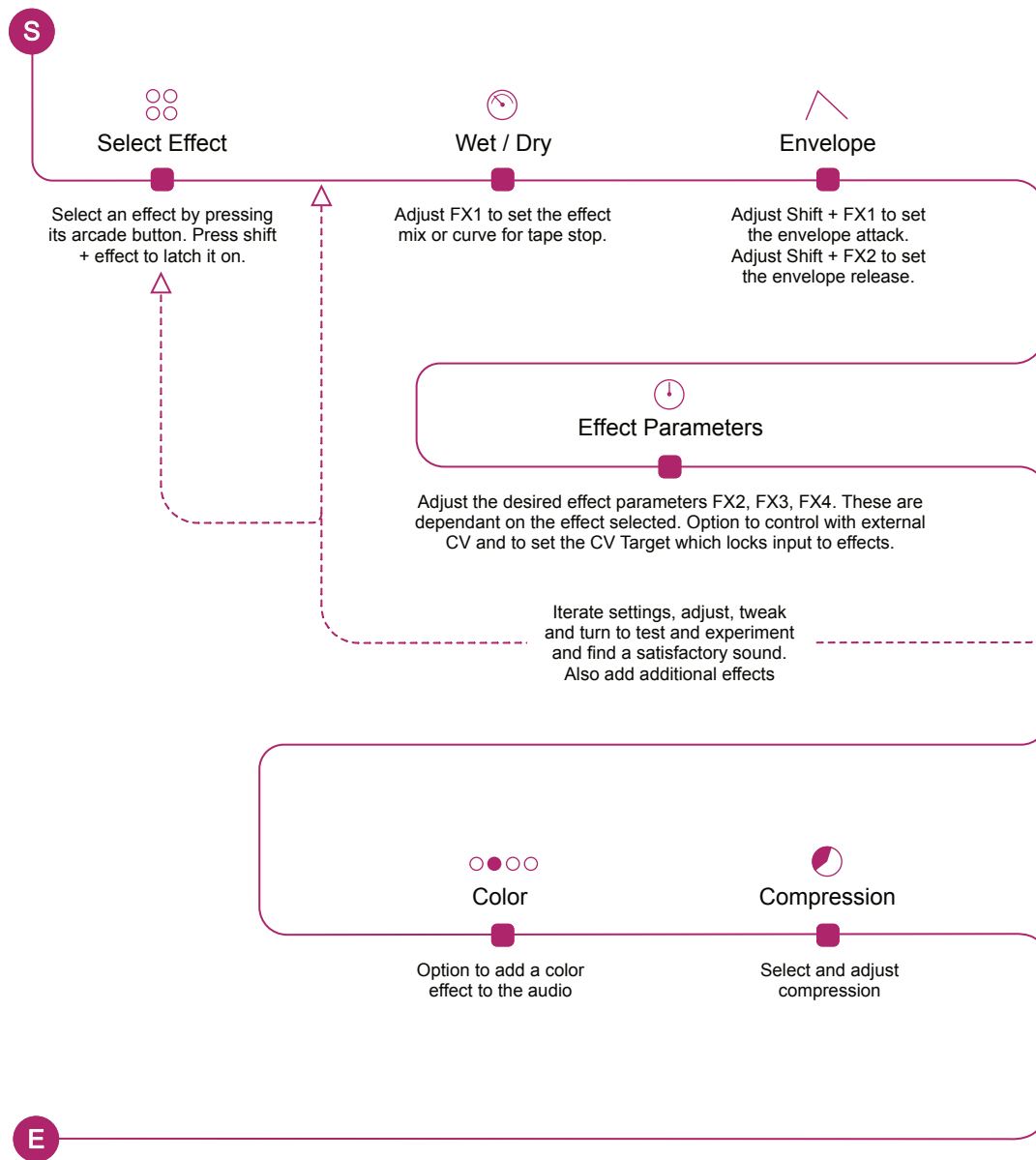

Basic Operation.

Performance effect arcade buttons.

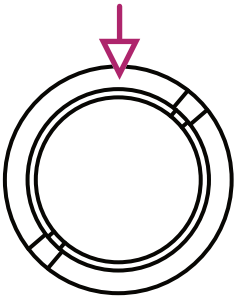

- PRESS - Trigger the effect momentarily.
- HOLD - Trigger the effect continuously.
- SHIFT + PRESS - Latch the effect on / off.
- Trigger can be applied using an external gate.

Performance / Processing FX controls.

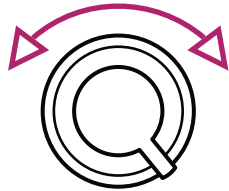

- TURN - Adjust a selected effects primary parameter.
- SHIFT + TURN - Adjust the secondary parameter.
- Control can be applied using an external CV.

Color processing effects

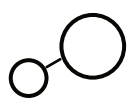

- PRESS - Color on (LED on), off (LED Off).
- SHIFT + PRESS - Cycle color presets.
- HOLD >2 Secs to select CV Target mode. Press arcade buttons to lock the selected effect to CV while holding color button.

Compressor processing effects

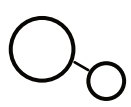

- PRESS - Compressor on (LED on), off (LED Off).
- SHIFT + PRESS - Cycle the sidechain input options.
- HOLD + TURN FX to adjust compressor settings.

General buttons



- Tap button. Tap (twice minimum) to set a BPM.
- Shift Button. Hold along with another button for secondary options.

AUDIO INPUTS AND OUTPUTS

Per4mer has stereo functionality provided by 2 mono inputs which are the source for the left and right audio signal to be processed. The processed signal is fed to the audio left and right outputs. Both input and output connections take 3.5mm / 1/8th Inch TS (Tip & Sleeve) audio jack plugs.

When only a single connection is made into the left input the left audio normalizes also to the right audio input.

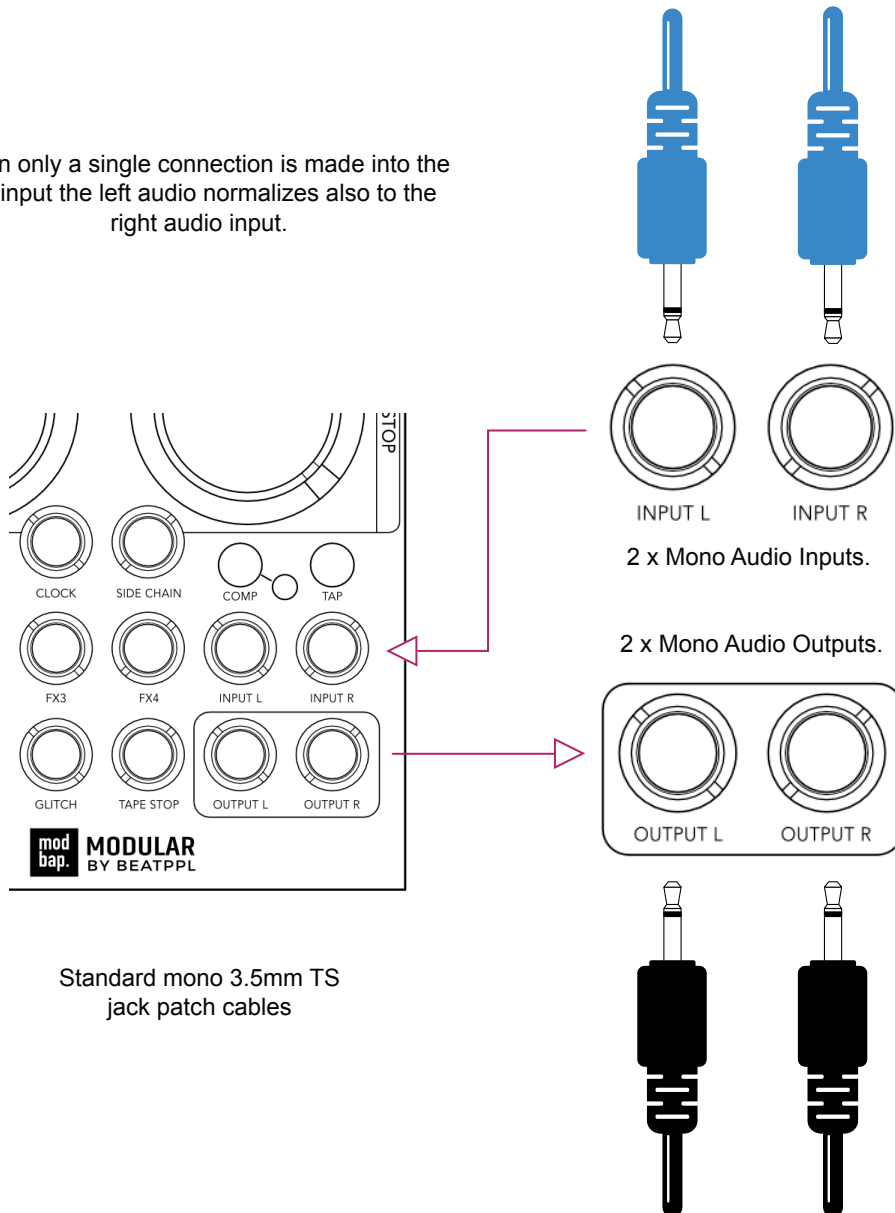

TRIGGERING ONE OR MORE PERFORMANCE EFFECTS

1. Connect the audio inputs of the audio to process. If using only a single input is connected to the left channel, audio will also normalize to the right input for stereo processing. Inputs are typically from another module which acts as the sound source.
2. Connect the audio outputs to the next module audio inputs or to an audio amplifier or speaker.
3. Tap or hold one or more performance effect arcade buttons to trigger its effect. These are momentary triggers and the effect is released when the button is released.
4. Hold Shift + Press the performance arcade button to latch the effect to on. Press the arcade button again to release.

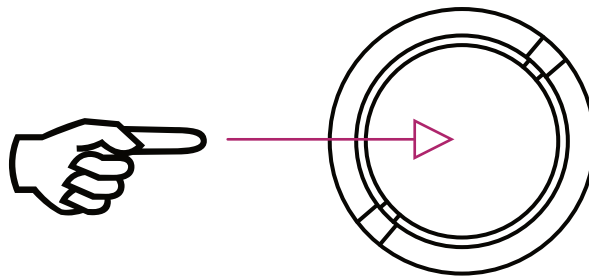

SETTING THE DEVICE TEMPO

1. Tap the 'tap' tempo button several times (> 2 taps) to set an internal Per4mer BPM at the tapped rate.
2. The color button LED will flash as a visual indicator of the tempo set.
3. If an external clock is connected it will override the manual setting although tap tempo can be momentarily applied to change BPM as an effect.

ADJUSTING A PERFORMANCE EFFECT PARAMETER MANUALLY

1. Press an arcade button to trigger the effect. The FX controls are assigned to the last effect applied whether still active or not.
2. Turn the desired effect FX1 - FX4 to adjust the desired parameter. FX1 to FX4 are context sensitive meaning that a specific parameter set is assigned to each effect. Therefore the dedicated parameters for the effect are assigned to FX1-FX4 when each effect is selected. CV Control (if applied) will also affect the parameter.
3. To reselect a latched effect to be in focus for parameter adjustment without unlatching it, Press Shift + Press the desired effect arcade button.

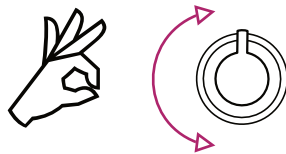

ADJUSTING A PERFORMANCE EFFECT ENVELOPE

1. Press an arcade button for the effect to adjust. The FX controls are assigned to the last effect applied whether still active or not
2. Hold Shift + Turn FX1 to adjust the selected effect envelope attack time.
3. Hold Shift + Turn FX2 to adjust the selected effect effect envelope release time.

Performance Effect Envelopes

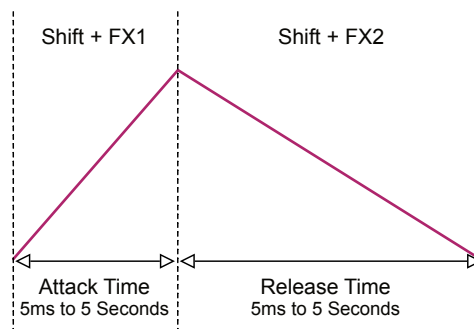

SETTING THE COLOR PROCESSING EFFECT

- 1. Press the color button to select the effect to ON (LED illuminated) or OFF (LED is off). The previously selected effect will be selected when switching it on.
- 2. Shift + Press the color button to cycle through and to select one of the four available presets. The selected preset is identified by the LED color.
- 3. The effect is off when the LED is unlit. The Color LED will also flash at the BPM rate of the clock or manually set tempo.

Off - LED off.



Purple - Classic



Teal - LoFi.



Color control. Tap to cycle on / off.

Orange - Saturation



Blue - Wax



Flashes in time with tempo



SELECTING THE COMPRESSOR PROCESSING EFFECT

1. Press the comp button to select compression ON (LED illuminated) or OFF (LED is off).
2. To adjust a compressor setting hold Comp + turn the FX control FX1 - FX4
 - FX1 - Threshold
 - FX2 - Ratio
 - FX3 - Attack time of compressor
 - FX4 - Release time of compressor
3. A typical workflow when setting the compressor is to start with a low ratio setting then reduce the threshold to enable the compressor to kick in. Iterate small parameter adjustments along with attack and release and increase ratio to find a desirable setting.

Compression Settings

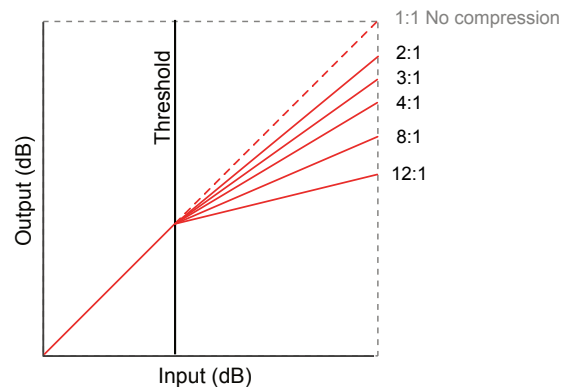

FX2 Compression ratio options are 2:1, 3:1, 4:1, 8:1, 12:1



External Control

PER4MER

All four effect arcade buttons and the associated FX controls can be controlled with the gate and CV control inputs respectively. Also an external clock can be connected as well as an external sidechain input to control the compressor. Adding modulation control over the Per4mer effects brings even more creativity and automated control to almost all of its features inspiring new ideas and experimentation. CV Inputs can be CV targeted to selected effects, locking the input control to the selected effect and providing direct CV control.

CONTROL INPUTS

Per4mer provides voltage control over the FX rotary controls using the CV inputs. These will control the selected FX and associated parameters. Gate inputs allow other modular and external gear to control the four performance effect buttons, triggering the effects on and off. Input connections are 3.5mm / 1/8th Inch TS (Tip & Sleeve) jack plugs.

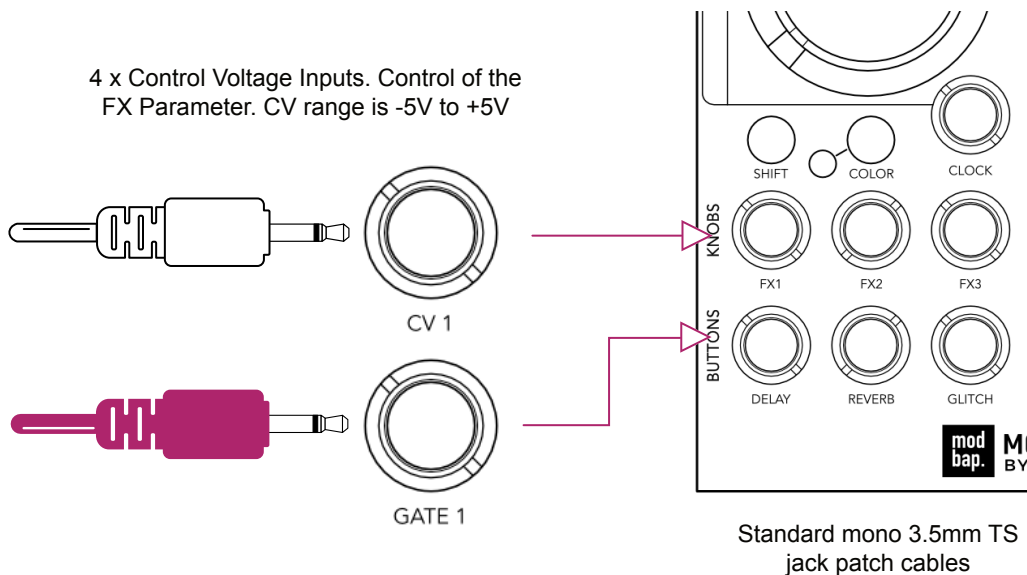

4 x Gate Inputs. Representing performance effect buttons. Gates are triggered above 1V

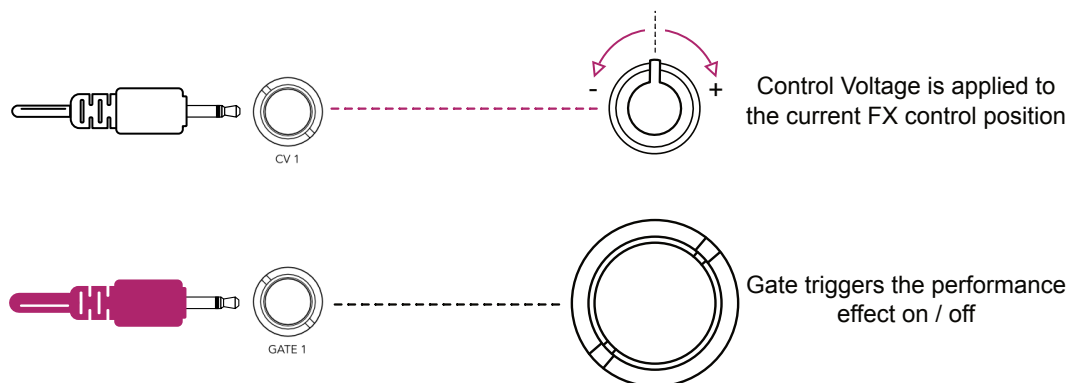

CONNECTING AN EXTERNAL CLOCK

1. Connect an external clock to the clock input. Per4mer will pick up on the external tempo BPM.
2. The internally set tempo is overridden by the external clock when connected.
3. Tap tempo can still be applied for momentary BPM effects.

GATE TRIGGERING ONE OR MORE PERFORMANCE EFFECTS

1. Connect a gate input to trigger the associated performance effect. This can be triggered by another modulation device such as a clock or sequencer.
 - Delay gate 1 will trigger the delay effect
 - Reverb gate 2 will trigger the reverb effect
 - Glitch gate 3 will trigger the glitch effect
 - Tape Stop gate 4 will trigger the tape stop effect.
2. A gate level above 1V input will latch the arcade button performance effect to on and will switch off when the gate falls below the 1V threshold.

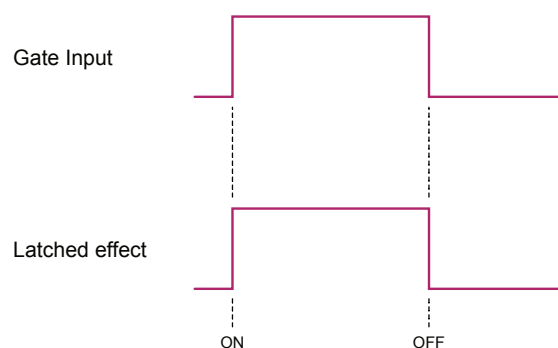

CONTROLLING A PERFORMANCE EFFECT PARAMETER BY CV

1. Connect a CV control from a modulation source to the respective CV input to control.
 - FX1 - CV1 will control FX1
 - FX2 - CV2 will control FX2
 - FX3 - CV3 will control FX3
 - FX4 - CV4 will control FX4
2. Hold Color for 2 seconds. Keep held. This will activate CV targeting for the arcade buttons which locks the CV input to the targeted arcade button effect. The targeted arcade buttons will show lit when CV Targeted to the inputs while effects which are not controlled by CV will have unlit arcade buttons.
3. With Color still held, press the arcade buttons to target. The buttons represent each effect and when on (lit) will lock the FX parameters to the CV input. Manually changing between arcade effects does not change the assigned CV controls when CV target locked. Press a lit arcade button to unlock the effect CV control. Release the Color button when complete.
4. The control will be applied to the FX setting using a +/- 5V CV input.
5. Hold Shift + Tap until the buttons flash to reset to defaults (Factory Reset).

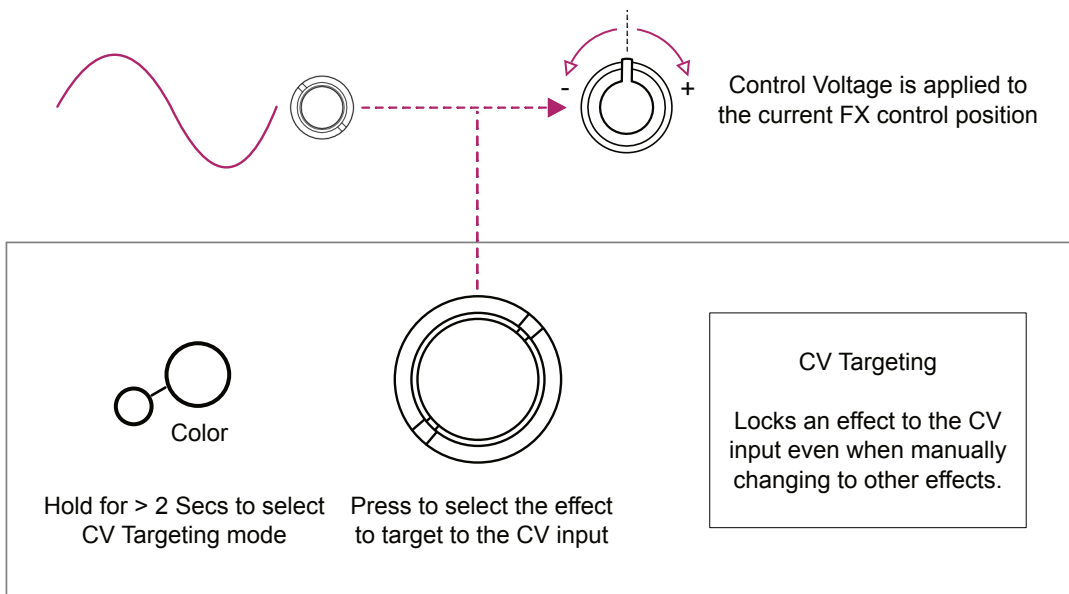

SETTING UP THE COMPRESSOR SIDECHAIN

Side chain is applied into the compressor audio engine to create a ducking / pumping modulation effect into the audio path. It can be driven by a number of sources.

1. Press Shift + Comp button to cycle the side chain source options. The sidechain sources available are:-
 - Audio input - White Comp LED
 - Sidechain CV Input - Teal Comp LED
 - Clock Input - Purple Comp LED
2. If using the dedicated external sidechain CV input, connect a modulation source to the sidechain input. This will be used to drive the compressor and offers more dynamic options.
3. Select audio as the sidechain source to use the audio input to drive the compression.
4. Any external clock connected to the clock input can also be selected to drive the compression. This is used where a more digital / cyclic control of the compressor is required.

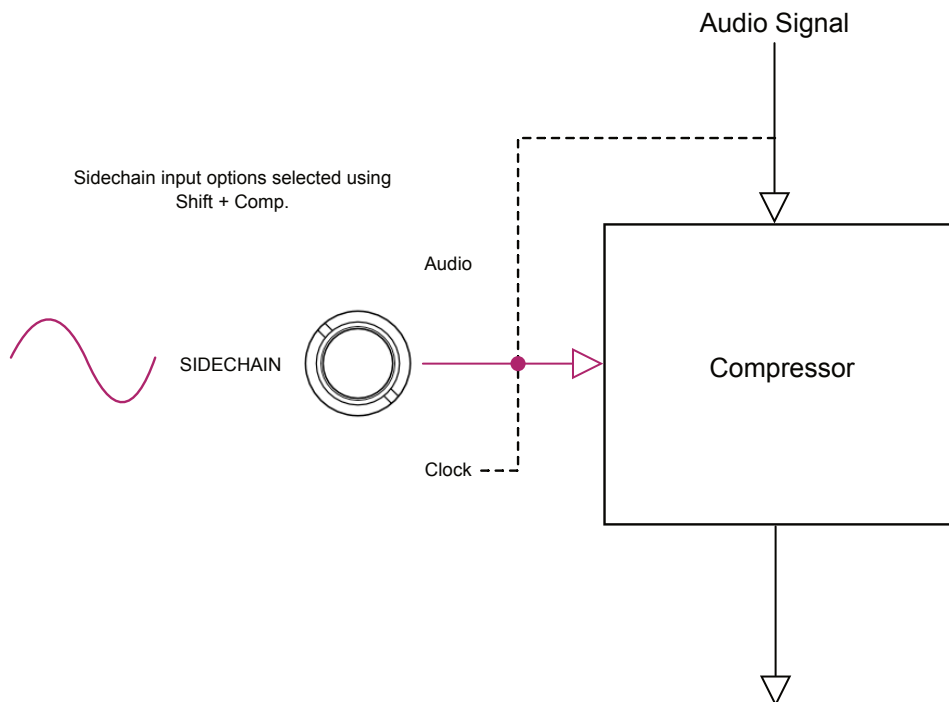



System

PER4MER

Firmware updates occasionally are made available as the module feature set develops and also to introduce system improvements. Description for the general update process is covered here but it is important to read and follow the instructions issued with each firmware update. The process described here is for general information and may be subject to change.

FIRMWARE UPDATES

Occasionally firmware updates are available. This may be to provide improvements to the functionality, fix bugs or add new features. Updates are applied using the micro USB connector on the rear of the unit and connecting to a PC or Mac.

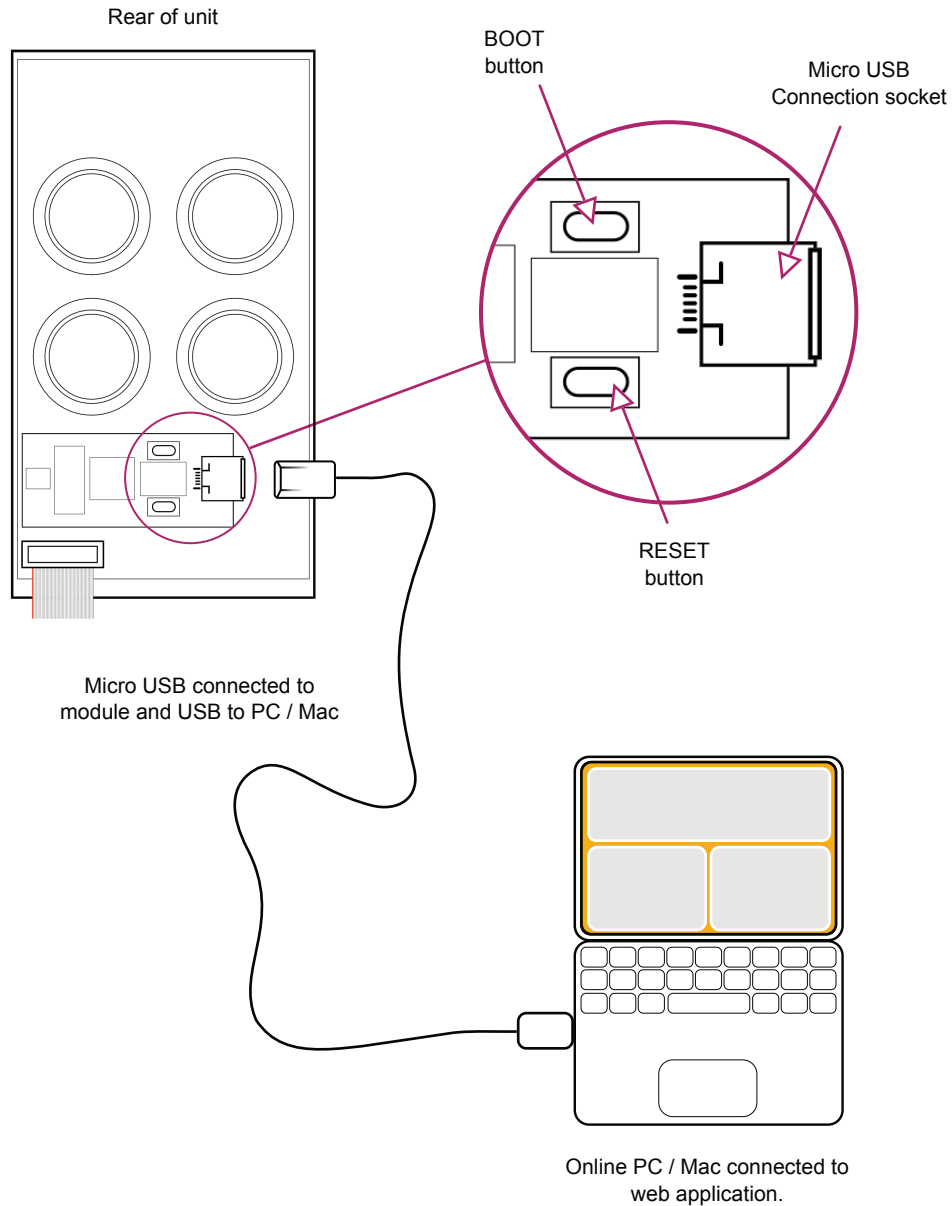

UPDATING THE FIRMWARE

The instructions below are a guide. Always follow the instructions that are provided with each update.

1. Download the firmware update.
2. Remove the device from the rack and ensure power is disconnected.
3. Connect device using a micro usb connection to the module and USB to a mac or PC. The module LED will illuminate. Power for the programming function is provided by the USB connection to the PC / Mac.
4. Open the programming utility at [electro-smith github](#) within the PC / Mac browser. It is recommended to use Chrome browser to ensure scripting compatibility.
5. On the module, firstly hold the boot button and then press the reset button. The module will enter boot mode and the LED may appear slightly brighter.
6. On the programming page, press 'Connect'.
7. The option pop up box will open and select 'DFU in FS Mode'.
8. Click the bottom left option to select a file using the browser. Select the .bin firmware update file from the PC / Mac.
9. Click 'program' in the bottom programming section window. The status bar indicators will show erase status followed by upload status.
10. When complete disconnect the usb connection and reinstall into the rack.
11. Power on the rack and module.

FACTORY RESET

1. Hold Shift + Tap for longer than 2 seconds.
2. The buttons will flash.
3. Per4mer will reset to the original default settings.



Limited Warranty

Modbap Modular warrants all products to be free of manufacturing defects related to materials and/or construction for a period of one (1) year following the product's purchase date by the original owner as certified by proof of purchase (i.e. receipt or invoice).

This non-transferrable warranty does not cover any damage caused by misuse of the product, or any unauthorized modification of the product's hardware or firmware.

Modbap Modular reserves the right to determine what qualifies as misuse at their discretion and may include but is not limited to damage to the product caused by 3rd party related issues, negligence, modifications, improper handling, exposure to extreme temperatures, moisture, and excessive force.

Per4mer and Beatppl are registered trademarks.

All rights reserved. This manual is designed to be used with Modbap modular devices and as a guide and aid to working with the eurorack range of modules. This manual or any portion thereof may not be reproduced or used in any manner whatsoever without the express written permission of the publisher except for personal use and for brief quotations in a review.

Version 1.0 October 2020

Manual designed by Synthdawg

www.synthdawg.com





BUILT FOR EURORACK
DOPE ENOUGH FOR BOOMBAP!



www.modbap.com