

1. Introduction

Module **A-112 (SAMPLER)** is a combination module, including a voltage controlled **8 bit Sampler** and a voltage controlled **Wavetable Oscillator**.

The module has the characteristic “**grungy**“ sound of the early **8 bit Samplers** and is a **welcome addition to the A-100’s sound generating capabilities**. But it should not be compared with the polyphonic 16 bit MIDI samplers available on the market.

The module contains an **A/D converter (ADC)** for recording the audio signal (8 bit resolution), **digital memory** for storage of the the sampled signal, a **D/A converter (DAC)** for playback and the **control unit**.

The memory is divided into two **banks (S1, S2)** with 64 kbyte each. In wavetable mode each bank is arranged as 256 **pages** of 256 bytes.

The memory is **non-volatile**, i.e. after power-off the sampling data in the memory is maintained.

Sampling mode

In sampling mode the incoming audio signal is sampled with a **sampling frequency** that is controlled **manually and from the external control voltage input**. The audio signal is converted by the ADC into 8 bit digital data and **sequentially** written into the memory (memory address 0 ... 65535). With a sampling frequency of 32kHz this corresponds to 2 seconds sampling time.

During playback the sampling data in the memory is read sequentially (address 0 ... 65535) and converted into the corresponding audio signal by the DAC. The sampling frequency in play mode is controlled manually and from the external control voltage input. Playback is stopped if the last memory address (65535) is reached.

Via **MIDI dump** the sampling memory can be sent to a computer for storing the data on hard-disk or any other storage device. The computer may also transmit sampling data to the A-112 via MIDI dump.

Wavetable mode

In wavetable mode the memory access is not sequentially but by **page**. The **page number** is selected by an **external voltage**. This voltage can be generated manually (e.g. with the manual control voltage

source A-176) or it may come from any other voltage source (e.g. LFO, ADSR, Sequencer). Both record and play take place in a **loop** whereby the **complete page** is always passed through. When reaching the end of a page the run control determines if a jump to another page takes place or the loop remains in the same page - depending upon the voltage controlling the wavetable/page.

Playback with a dynamic control voltage (e.g. ADSR, LFO, Random, Sequencer, MIDI-to-CV) results in "sweeping through" the different pages (**Wavetable principle**). If the memory of the A-112 contains suitable wavetables in the 256 pages, the result is a voltage controlled **Wavetable Oscillator** with two control voltages: one for the audio frequency (pitch, tune), one for the wavetable number.

Normally suitable wavetables are generated by a computer and transferred to the A-112 via **MIDI-Dump**.

Effect mode

Additionally the module offers some effects, like **Delay**, **Reverse Delay** and **Pitch Shifter**. Of course, due to the 8 bit resolution these effects are not to be compared however with the results from high-end effect devices, but should be considered as a free extra gift for strange sounds.

2. SAMPLER Overview

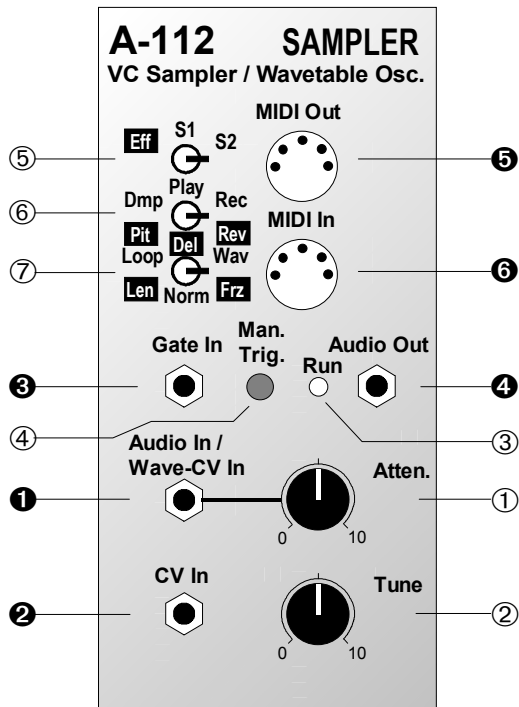

Controls:

- ① **Atten. :** Attenuator for Audio/Wave CV Input ①
- ② **Tune :** Manual control for Sampling frequency
- ③ **Run :** Gate indicator LED / overload warning during record
- ④ **Man. Trig. :** manual trigger/start button
- ⑤ ... ⑦ **Switches:** 3-position switches for mode selection

In / Outputs:

- ① **Audio / Wave-CV In:** Input for audio signal resp. wavetable control voltage in wavetable mode
- ② **CV In :** pitch control input (1V/oct.) for tuning or sampling frequency
- ③ **Gate In :** Gate input
- ④ **Audio Out :** Audio output
- ⑤ **MIDI In :** MIDI input
- ⑥ **MIDI Out :** MIDI output

3. Controls

① Atten.

Control ① attenuates the **level** of the voltage at input ❶. Depending upon the mode this voltage is the **audio signal** (in sampling or effect mode) or the **wavetable control voltage** (in wavetable mode).

② Tune

The tune control ② is used to adjust the **sampling frequency** (during record) or the **pitch/tune** during playback (see table below).

Exception: In **wavetable record mode** one of the 256 **pages** is selected with the tune control (see following table). In this case the sampling frequency defaults to the last frequency that was set prior to switching into wavetable mode.

tune position	page (appr.)	sampling-freq. [kHz]	tune-position	page (appr.)	sampling-freq. [kHz]
0	0	2,0	6	154	18,5
1	26	2,9	7	179	26,5
2	51	4,2	8	205	38,5
3	77	6,1	9	231	56,2
4	103	8,8	10	255	79,4
5	128	12,7			

The data in the table are approximate values



The voltage generated with the tune control is internally added to the voltage at input ❷. This input is normally used to control the pitch of the sampler/wavetable oscillator in play mode with an external control voltage following the 1V/oct standard (e.g. the A-190 MIDI-to-CV interface).

③ Run

LED ③ is used for different **monitoring purposes** depending upon the mode selected. A description of the respective function is given in the corresponding paragraph elsewhere in this manual.

④ Man. Trig.

Button ④ is used to trigger the sampler **manually**. Depending upon the mode selected a **Trigger** or **Gate** leads to different actions. A description of the respective functions is given in the corresponding paragraph elsewhere in this manual.



The manual trigger generated with button ④ and the signal at the gate input ❸ are internally connected, to produce a gate/trigger signal used for all triggered/gated functions.

⑤	⑥	⑦	Function
S1, S2	Dmp	Loop	not implemented
		Norm	Dump a sample
		Wav	Dump a wave
	Play	Loop	Play a loop
		Norm	Play a sample
		Wav	Play a wave
	Rec	Loop	Record a loop
		Norm	Record a sample
		Wav	Record a wave
Eff	Pit	Len	Input sample length required
		Norm	Pitch Shift
		Frz.	Pitch Shift with "Freeze"
	Del	Len	Input sample length required
		Norm	Delay
		Frz.	Delay with "Freeze"
	Rev	Len	Input sample length required
		Norm	Reverse Delay
		Frz.	Reverse Delay with "Freeze"

⑤ Switch • ⑥ Switch • ⑦ Switch

With the 3-position **switches** ④ to ⑥ the operating mode is selected. The table on the left lists all possible modes. The modes are described in the following paragraphs.

In particular the gate signal (gate input ③ / manual trigger ④) controls different functions in the respective operating modes.



Please note that in some modes it is not sufficient to change the switches position to exit the mode. In the following description of the modes you will find detailed information on how to exit a selected mode.

- **Normal record mode**

⑤	⑥	⑦	Audio / Wave-CV In	Tune / CV
S1, S2	Rec	Norm	Audio signal	sampling frequency (while Gate = low)

In this mode an audio signal at audio input ① is recorded into one of the 2 memory banks S1 or S2 (depending upon the position of switch ⑤).

Gate = low :

In this case the **pre-listening mode** is active (LED ③ is off); the audio signal at input ① is digitized by the ADC, re-converted by the DAC and forwarded to audio output ④ for pre-listening.

The pre-listening mode contains an **overload/ clipping function**: as soon as the audio signal exceeds a predefined upper or lower threshold the **LED ③** lights up for a short moment (about 10 ms). During this time the audio signal is not scanned and the output remains at the last DAC value. The onset of clipping (i.e. overload distortion) is immediately audible.

 The sound quality in the pre-listening mode is very poor. The quality if a signal is recorded and played back is much better!

The **pre-listening mode** is also used to find out and set the **sampling frequency**. When record mode is entered (see below) the last sampling frequency in pre-listening mode is used.

Gate = high:

When the gate level changes from low to high **Record** is triggered and the audio signal is sampled into the memory bank selected with switch ⑤. LED ③ is now on. Recording starts at address 0 and continues until the last address (65 535) is reached and LED ③ turns off. If gate turns low before the end of the sampling memory (address 65 535) is reached the record process stops. You can use this function to sample chosen segments of sound.

- **Normal play mode**

⑤	⑥	⑦	Audio / Wave-CV In	Tune / CV
S1, S2	Play	Norm	-----	sampling frequency

In this mode a previously recorded sample in the sampling memory (S1 or S2, depending upon the position of switch ⑤) is played back.

Gate = low:

The module is waiting for gate = high; LED ③ is off (see fig. 1 - a).

Gate = high:

When the gate level changes from low to high **Playback** is triggered and the audio signal in the memory bank is played back. LED ③ is now on. Playback starts at address 0 and continues until the last address (65 535) is reached and LED ③ turns off. Even if the gate goes low before the end of the sampling memory is reached the playback continues (see fig. 1 - b).

Only if the gate goes low and high again before the end is reached the sample is **retriggered**, i.e. the playback starts again at address 0 (see fig. 1 - c).

If the gate is still high when the end of the sample memory is reached the playback stops (i.e. no loop if gate remains high). For this purpose the loop mode is used.

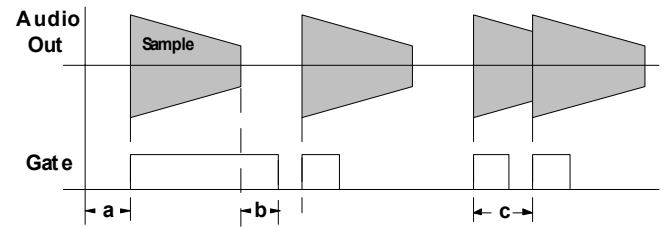

fig. 1: normal play mode

- **Loop record mode**

⑤	⑥	⑦	Audio / Wave-CV In	Tune / CV
S1, S2	Rec	Loop	audio signal	sampling frequency (only if Gate = low)

This mode is very similar to the normal record mode (see above). The only **difference to the normal record mode** is that **record continues** when the **end of the sample** memory is reached and the **gate level is still high**.

In this case the record starts again at the first memory address. This loop continues (LED ③ on) until gate turns low.

• **Loop play mode**

⑤	⑥	⑦	Audio / Wave-CV In	Tune / CV
S1, S2	Play	Loop	-----	sampling frequency

In normal play mode the playback stops if the end of the sample memory is reached. The loop play mode allows the **continuous playback of a pre-defined section** of the sample memory.

Gate function:

As long as the gate level is high the sample is played continuously. When the end of the sample is reached, playback starts again at the beginning (see fig. 2 - a). LED ③ is on.

As soon as the **gate goes low** the present position within the sample is defined as **loop end** (see fig. 2 - b). Playback starts at the beginning (address 0) and runs continuously from the beginning to the loop end

as long as the gate level remains low (see fig. 2: loop 1).

If gate turns high (see fig. 1 - c) the loop end is cancelled and the sample playback uses the full range again (i.e. loop end = end of sample memory, see fig. 2 - d).

If the gate goes low again a new loop end is set (see fig. 2 - e, loop 2).

To **exit** loop play mode a short **trigger pulse** (max. duration 100 ms) is required (see fig. 2 -f).

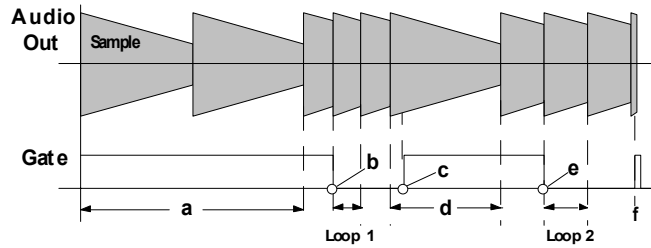

fig. 2: Loop play mode

- **Wave record mode**

⑤	⑥	⑦	Audio / Wave-CV In	Tune / CV
S1, S2	Rec	Wav	audio signal	sampling frequency (if gate = low) / wavetable number (if gate = high)

In this mode one or more **wavetables** are recorded into the memory bank selected.

The **number of the wavetable (page)** results from the position of the **Tune control** ② and the voltage applied to the **CV input** ②.

Gate = low :

The **pre-listening mode** is active (LED ③ is off); the audio signal at input ① is digitized by the ADC, re-converted by the DAC and forwarded to audio output ④ for pre-listening.

All functions and controls (overload/clipping, adjustment of sampling frequency ...) are the same as in the normal record mode (see above).

Gate = high:

When the gate goes high **record** starts (**LED** ③ is on). The last sampling frequency while gate was low is used as the sampling frequency. The wavetable number (page) is derived from the position of the **Tune control** ② and the voltage applied to the **CV input** ②. The audio input is sampled and 256 bytes are written into the wavetable memory (page) selected.

When the last byte of the page (i.e. byte no. 256 of the page) is written record starts again at the first byte of the page. This process continues (LED ③ on) until the gate goes low.

The record process stops immediately at the present position as soon as the gate goes low. You can use this function to sample chosen segments of sound.

When reaching the last position of the current wavetable page the number of the next page is defined by the position of the Tune control ② and the voltage applied to the CV input ② (provided that gate is still high). Consequently different pages may be selected during record if the control voltage (e.g. from an ADSR) or the position of the tune knob is changed .

In fig. 3, the CV input is fed from the sine output of a LFO. The sampling frequency is 32kHz, the LFO frequency 21 Hz. The resulting wavetable pages are shown in the boxes.

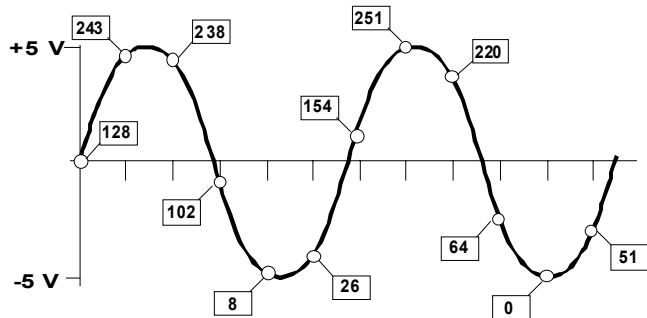

fig. 3: wave record mode with modulated wavetable page number

Waves recorded in this way may be played back in the normal play mode, often leading to some fairly drastic effects.

• Wave play mode

⑤	⑥	⑦	Audio / Wave-CV In	Tune / CV
S1, S2	Play	Wav	Number of wave-page	sampling frequency

In this mode A-112 works as a **wavetable oscillator**. The **wavetable number** (page) that determines the sound of the audio output is set by the control voltage applied to the **audio/wave CV input ①**

Gate = low:

The module is waiting for gate = high; LED ③ is off.

The initial sampling frequency (i.e. the first frequency when gate turns to high, see below) is set. **Pre-listening mode** is also used to find out and set the **sampling frequency**.

Gate = high:

When the gate goes high the wavetable number (audio/wave input) and the sampling frequency (tune control and CV input) are set, and playback of the recorded wavetable begins, using the sampling frequency previously set (LED ③ turns on). When the end of the wavetable is reached the process starts again,

i.e. the next wavetable and the next sampling frequency are determined. This continues until the gate goes low.

When a dynamic voltage -2.5...+2.5V is used as the wavetable control voltage (e.g. ADSR output connected to audio/wave input ①) wavetable are swept.

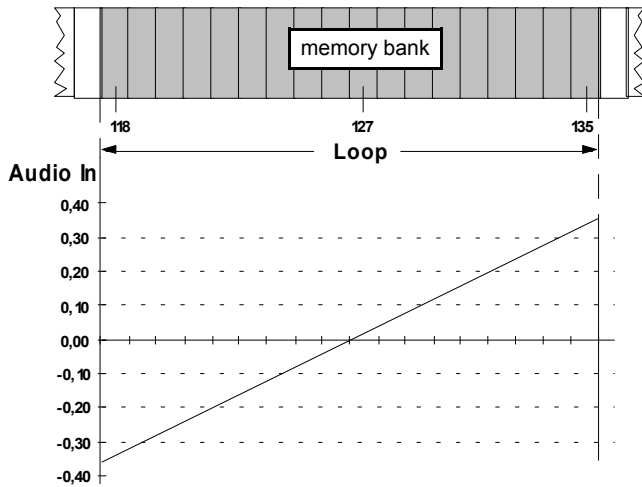

fig. 4: wavetable selection with CV voltage applied to audio/wave input

• Normal dump mode

⑤	⑥	⑦	Audio / Wave-CV In	Tune / CV
S1, S2	Dmp	Norm		

In this mode a sample (bank 1 or 2) can be transferred as a **MIDI system exclusive string (SysEx Dump)** via MIDI out ⑥. You can then record this string with a MIDI computer sequencer or download it using a MIDI dump program for storage on hard disk or any other storage device. The sampling frequency is also transferred within the string.

It is also possible to receive a **sample dump** via MIDI input ⑤. The dump is written to the memory bank selected (S1 or S2).

Gate = low:

In this state (LED ③ off) MIDI input ⑤ is scanned. As soon as an **incoming sample dump** is detected LED ③ turns on and the dump data is written into the memory bank selected.

If a **sample dump request** is received via MIDI IN the sample memory is transferred via MIDI OUT as a SysEx string. LED ③ turns on as well. Refer to the description of MIDI input and output in chapter 5.

 During Data transmission via MIDI OUT the MIDI input and gate are not scanned. Therefore a new dump cannot be triggered by mistake.

Gate = high:

As soon as the gate goes high (e.g. by pressing button ④) the sample memory is transferred as a SysEx dump via MIDI OUT and LED ③ turns on (same function as sample dump request via MIDI in).

 To trigger a sample dump manually a short high gate level is sufficient. It is not necessary to keep the gate level high.

• Wave dump mode

⑤	⑥	⑦	Audio / Wave-CV In	Tune / CV
S1, S2	Dmp	Wav		wave page number

This mode is very similar to the normal dump mode (see above). The **difference from the normal dump mode** is that the data of a **single wavetable** (page) of 256 bytes is **transferred** instead of the complete sampling memory of a bank.

The **number of the wavetable** is determined by the position of the tune control ② and the voltage applied to CV input ②.

• Delay mode

⑤	⑥	⑦	Audio / Wave-CV In	Tune / CV
Eff	Del	Norm	audio signal	sampling frequency

This mode generates a simple **delay**. The incoming audio signal is delayed and passed to the audio output.

 **The memory bank S2** is overwritten in this mode!

Principle: The incoming audio signal is sampled and written into a memory position in bank S2. Before this the old value at this position is transferred to the audio output. The number of the memory position is increased by 1 and the process is repeated. When reaching the last memory position the process starts at memory position 1. The last memory position depends upon the length (Len, see below).

The **length** of the delay memory is defined by the parameter **Len** (see below). The maximum length is the complete sampling memory (64kbyte = 65536 bytes). With a sampling frequency of 32 kHz this corresponds to 2 seconds delay time. The **actual delay time** is decided by a combination of the **length of the delay memory** (Len) and the **sampling frequency**.

Gate = low:

The module is waiting for gate = high; LED ③ is off. The initial sampling frequency is set.

Gate = high:

The delay mode is started; LED ③ turns on. Retrigger is active, i.e. a gate transition to low and back to high starts the delay mode again.



Moving from delay mode directly to delay with freeze is not possible. To perform this one has to interrupt the delay mode (switch ⑤ to S1/S2 or switch ⑦ to Len) and then select the desired mode.



By feeding the A-112 output back to its input one obtains a repeat or echo (see fig 5). Beware: too much feedback leads to an avalanche-like effect. In this case the feedback component has to be reduced.

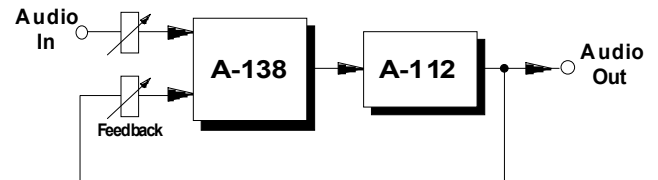

fig. 5: Echo

- **Reverse delay mode**

⑤	⑥	⑦	Audio / Wave-CV In	Tune / CV
Eff	Rev	Norm	audio signal	sampling frequency

This mode is the same as the delay mode but the playback of the delayed signal takes place in reverse.



Memory bank S2 is overwritten in this mode!

Principle: Same as the normal delay mode but writing into the delay memory is performed forward, and reading the delay memory is performed backward. As this is a very simple “bog standard” algorithm, overlapping effects may occur and lead to interference, glitches or clicks in the audio output signal.

 All functions and controls (sampling frequency, length of delay memory ...) are the same as in the normal delay mode (see above).

- **Pitch shift mode**

⑤	⑥	⑦	Audio / Wave-CV In	Tune / CV
Eff	Pit	Norm	audio signal	sampling frequency

In pitch shift mode the audio input signal is sampled and played back at the audio output with shifted pitch/tuning.

 **Memory bank S2** is overwritten in this mode!

Principle: The incoming audio signal is sampled with a fixed sampling frequency (about 16 kHz) and written into memory bank S2. Each sample increases the memory position by 1. Simultaneously the memory is read out with a sampling frequency that is determined by the Tune control ② and the voltage applied to the CV input ②.

If the read frequency is nearly the same as the write frequency (i.e. about 16 kHz) no pitch shift occurs - just a delay depending upon the memory length (Len).

If read and write frequency differ the audio signal is read out faster or slower and the pitch shift effect occurs.

Because of this very simple “bog standard“ algorithm overlapping effects may occur and lead to interference, glitches or clicks in the audio output signal.

 All functions and controls (read sampling frequency, length of delay memory ...) are the same as in the delay mode (see above).

 Very interesting sounds can be obtained if the original audio signal is mixed with the pitch shifted signal of the A-112 (using a mixer A-138a/b).

- **Freeze option**

⑤	⑥	⑦	Audio / Wave-CV In	Tune / CV
Eff	Del, Rev, Pit	Frz.	audio signal	sampling frequency

The effect modes delay, reverse delay and pitch shift may also run with the **Freeze option**.

In this case the audio input is no longer sampled and the memory data no longer overwritten. Instead, the **frozen** memory data are played back. The parameters memory **length** (Len) and **sampling frequency** determine the effect.

Gate control:

The module is waiting for gate = high; LED ③ is off. The initial sampling frequency is determined.

If only a short **gate pulse** appears (i.e. gate turns to high only for a short time and becomes low again) the effect selected functions **without freeze**. LED ③ is off.

As soon as **gate turns high and remains high** the **freeze option** of the effect in question is **active**. LED ③ is on. The data in the memory are "frozen" as long as the gate remains high.

When **gate turns low** the **freeze option** is **cancelled** and the module returns to the respective effect without freeze. To re-activate the freeze option, one simply has to turn the gate to high.



Changing directly to the normal effect without freeze (permanently) is not possible. To perform this one has to interrupt the freeze option (switch ⑤ to S1/S2 or switch ⑦ to Len) and select the desired mode after this.

- **Effect parameter "Len"**

⑤	⑥	⑦	Audio / Wave-CV In	Tune / CV
Eff	Del, Rev, Pit	Len		memory length for the effect in question

In this operation mode the parameter **Len** is adjusted. This value determines the **length of the sampling memory** in bank S2 used for the effect modes.

Gate = low:

In this state the **Tune control** ② adjusts the **Len** parameter. The resolution for the length is one page (256 bytes). The tune knob turned fully to the left (ccw position 0) corresponds to one page, turned fully to the

right (cw position 10) it corresponds to the whole memory (64 kbyte or 256 pages). During the adjustment of Len with the tune control no external voltage should be applied to the CV input ②.

Gate = high:

As soon as the gate goes high the current position of the tune control is used to set the Len value.

For the different effect modes the following notes also apply:

Delay, Pitch Shift:

The **factory setting** is **4 kBytes** (i.e. 16 pages). This corresponds to a tune control setting of about 0.5.

Reverse Delay:

The **factory setting** is **64 kBytes** (i.e. 256 pages). This corresponds to tune control setting 10.

The reverse delay effect seems to go very strange with tune control settings of about 1.5 down to 0, i.e. the reverse delay becomes a normal delay, but with extreme distortion.

4. In / Outputs

① Audio In / Wave-CV In

At this socket the **audio input signal** is patched in (i.e. the signal to be sampled or used for effects). This is a line level input (+/-2.5V or 5Vss). Note that the audio signal must be at line level – microphones won't give enough output.



Exception: In **wavetable play mode** this is the wavetable control voltage input - 2.5...+2.5V (not an audio signal input)!

② CV In

Control voltage input for **sampling frequency** during **record**, or **pitch/tune** during play. This input follows to the 1V/oct. standard and has 1/4 semitone resolution.



The control voltage applied to CV in ② is internally added to the voltage generated by the tune control ②.

③ Gate In

At the **Gate input** ③ the **gate signal** is patched in. The function depends upon the mode selected.

 The gate signal applied to this socket is internally connected with the signal coming from the button ④. If either of these is high, the module gate is high.

Gate In ④	Man. Trig. ⑦	result. Gate
high	high	high
high	low	high
low	high	high
low	low	low

④ Audio Out

Socket ④ is the **audio output** of the A-112.

 The audio signal from the DAC passes a simple **low-pass filter** to suppress the sampling frequency. It is possible to bypass this internal filter if a more sophisticated low-pass filter (A-120, A-121, A-122) is used or if the sampling frequency should not be suppressed for special effects. For this the internal jumper J1 has to be removed.

⑥ MIDI In

Socket ⑥ is the **MIDI input** used to receive sample data (SysEx dump) via MIDI. For this the dump or wave dump mode has to be selected (see above) and the gate has to be low.

Moreover a sample dump request or a wave dump request message can be received by the A-112 in this mode.

The MIDI SysEx message for a **sample dump request** has the following structure:

```

F0
00 20 20 Doepfer SysEx-ID
7F
< bank>    bank number (00 : S1, 01 : S2)
F7

```

When receiving this message the A-112 transmits at the **MIDI output ⑥** a **sample dump** (LED is on). The length of the dump is 74.909 bytes altogether. Additionally the current sampling frequency is transmitted.

The SysEx message for a **wave dump request** has the following structure:

```

F0
00 20 20 Doepfer SysEx-ID
7D
< Wave-Nr., Bit 7 - 1 >
< Wave-Nr., Bit 0 >
F7

```

As the data range in a SysEx message is 0...127 (7 bit) the wave number requires 2 bytes.

Example: Dump of wave no. 201 ("11001001"):

```

F0
00 20 20
7D
64          "110100"
01          "1"
F7

```

When it receives this message the A-112 **transmits a wave dump** at the **MIDI output ⑥** (LED is on). The length of the dump is 305 Bytes altogether. Additionally the current sampling frequency is transmitted.

⑥ MIDI Out

The **MIDI output ⑥** transmits MIDI dump information during sample or wave dumps.

5. User Examples

The obvious application of the A-112 is the sampling and playback of external sounds or sounds generated with other A-100 modules. On top of this the module opens up a huge number of sound experiment possibilities – far too many to be covered in this manual.

The following examples concentrate on **wavetable** applications of the module.

Wavetable Oscillation

The wavetable oscillator feature and the loop feature of the A-112 have already been described in chapter 3. Smooth sequencing of the wavetables with an external control voltage requires a certain amount of subtle intuition - and additional A-100 modules - as it is necessary to control the offset and amplitude of the voltage applied. You do then also have the ability, though, of selecting a specific starting wavetable (offset) and starting the up/down sweep through the waves (amplitude) at this particular point.

For the most effective wavetable control we recommend using the A-129/3 (attenuator and offset generator, see below).

The control voltage range 0...+5V corresponds to the 256 tables (0V = table no. 1, +5V = table no. 256). To move from one table to the next one a voltage difference of about 0.02 V (5V/256) is required.

Example: To sweep with an LFO (Triangle output) through 64 tables starting with table no. 96 (i.e. passing through the tables 64...128) the following conditions are required: An offset voltage of $96 \cdot 5V/256 = 1.875V$ and an attenuation of the LFO signal to $64 \cdot 5V/256 = 1.25V$ (peak-to-peak). Using a A-129/3 the offset voltage is adjusted with the offset control and the LFO level with the attenuator control.

If each of the 64 tables are to be used - i.e. none of the tables is to be skipped - there is a maximum frequency that the controlling signal (LFO) must not exceed. If the sampling frequency is 32kHz each wavetable (256 byte) takes 8 milliseconds. All 64 tables take 512 milliseconds. This corresponds to 1.95 Hz LFO frequency. Consequently the frequency of the LFO must be about 2 Hz or less to play each table without skipping. This sounds very mathematical and theoretical but it is a good idea to understand these facts as some unforeseen things may happen if one ignores these details. In practice of course the resulting sound is all that counts.

Sequencer-controlled wavetable playback

In the patch in fig. 6 the Analog/Trigger Sequencer A-155 controls the **playback of different wavetables** (step 1, 4, 5 and 7).

The sawtooth output of the LFO, patched via offset generator A-129/3 generates the control voltage to sweep through the wavetables. This voltage is added to the sequencer voltage (post out 2). Thus different ranges of the wavetable memory are used for each step (displayed by different sound symbols). Regarding offset, attenuation and LFO frequency, see the notes on the previous page.

The sequencer control voltage Post Out 1 is used to control the decay of an VC-ADSR, i.e. for different decay times for each step.

Instead of an LFO an ADSR or VC-ADSR may be used. The attack control is used in this case to adjust the speed of sweep (decay, sustain and release control = 0).

Wavetable playback of a normal sample

Very interesting sounds can be obtained if a normal sample is played back in wavetable mode - especially if human voice is recorded.

During normal sample playback the sample length depends upon pitch and the so-called Mickey Mouse effect occurs.

If the wavetable mode is used the sample length depends only upon the slope of the controlling voltage (e.g. sawtooth) but not upon the pitch. This is adjusted independently with the tune control and pitch CV.

Suggestions for sound experiments:

- If the slope of the voltage controlling the wavetable is running backwards (e.g. a falling sawtooth) sampled words seem to be spoken backwards (sort of).
- By selective scanning of a spoken sample one may obtain voice or vowel loops.
- Using a random or S&H voltage for controlling the wavetables leads to the basics of what is often referred to as granular synthesis.

For the above suggestions it is important that the period of the sampled sound fits almost exactly into the space allotted to each wavetable (256 Bytes). If the result is not satisfactory another record sampling frequency should be used until the desired sound is obtained.

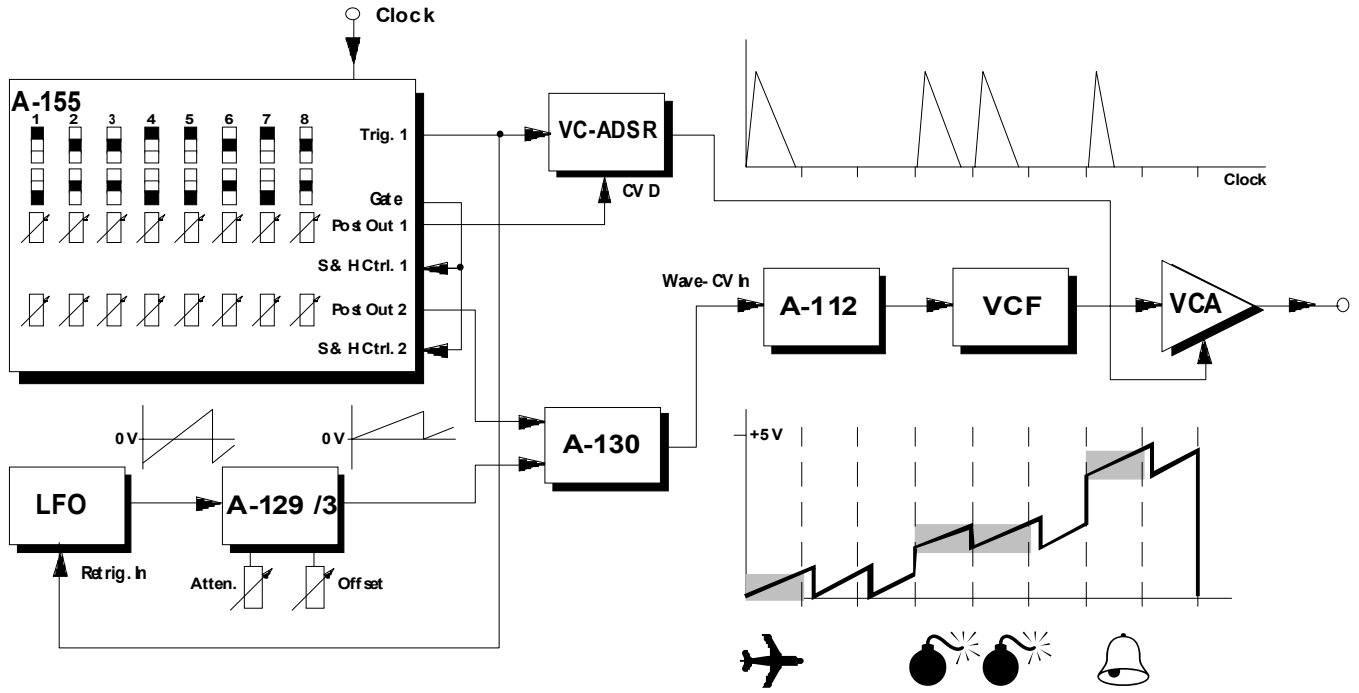

fig. 6: sequencer-controlled wavetable playback

6. A-112 Sample Dump Loader

The A-112 MIDI interface enables the transfer of sample and wave data from and to the device using MIDI SysEx strings. For that purpose a standard MIDI sequencer may be used.

In addition we include a 3 1/2" floppy disk containing a **A-112 sample dump loader** software for PC.

Version 1.2 of this software (see fig. 7) enables bi-directional transfer between A-112 and the PC. Samples and waves can be organized and stored on the storage device (e.g. hard disk) of a PC. In the PC each sample or wave can be assigned any name (DOS convention, i.e. max. 8 characters) and stored as a **WAV file** (8 bit mono). The A-112 format is automatically converted into the WAV format.

Conversely, **any WAV file can be transferred to the A-112**. The program reads any WAV file in 8, 12 or 16 bit mono or stereo formats. Stereo WAV files are converted to mono before transfer to the A-112.

The WAV file format opens up a wide pool of sounds for use with the A-112. You may try out Windows system sounds or modifying sounds with a sample editor program and then re-loading back into to the A-112.

For the next version of the sample dump loader program we are planning to include the ability to generate sample dump MIDI files.



The **latest version** of the sample dump loader can be found on our **internet homepage** (<http://www.doepfer.com>) for free download.

7. Patch-Sheet

The following diagrams of the module can help you recall your own **Patches**. They're designed so that a complete 19" rack of modules will fit onto an A4 sheet of paper.

Photocopy this page, and cut out the pictures of this and your other modules. You can then stick them onto another piece of paper, and create a diagram of your own system.

Make multiple copies of your composite diagram, to use for remembering good patches and set-ups.



- Draw in patchleads with coloured pens
- Draw or write control settings in the little white circles

