

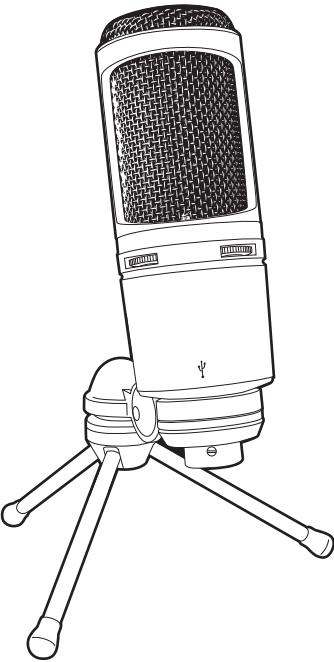

# AT2020USB+

**User Manual**  
Cardioid Condenser USB Microphone



## Safety precautions

---

Although this product was designed to be used safely, failing to use it correctly may result in an accident. To ensure safety, observe all warnings and cautions while using the product.

### Cautions for the product

- Do not subject the product to strong impact to avoid malfunction.
- Do not disassemble, modify or attempt to repair the product.
- Do not handle the product with wet hands to avoid electric shock or injury.
- Do not store the product under direct sunlight, near heating devices or in a hot, humid or dusty place.

---

## Notes on use

---

- Be sure to read the connected device's user manual before use.
- When the product is used for a long time, the product may become discolored due to ultraviolet light (especially direct sunlight) and wear.
- Use the included USB cable for connection.
- Make sure to hold the plug when connecting and disconnecting the USB cable. The USB cable may become severed or an accident may occur if you pull on the USB cable itself.
- When using the USB cable, be careful not to twist it to prevent damage to the USB cable.
- Do not wind the USB cable at the base of the plug to prevent a disconnection.
- Do not use a USB hub or USB extension cable.
- When plugging the USB cable into the microphone and the connected device, check that the connector is facing in the correct direction before inserting it straight. Inserting the plug diagonally may cause a malfunction.
- When not in use, disconnect the USB cable from the product.
- Make sure that no foreign matter enters inside the mesh part of the product. Performance may be degraded.
- For important recordings, perform a trial recording beforehand to make sure that the sound is recorded correctly.
- Operation is not guaranteed with all computers.
- Operation cannot be guaranteed in a home-built computer, personal OS upgrade, or multi-boot environment.
- Audio-Technica will not be liable in any way for any loss or damage to software or data connected to the product.

## Part names and functions

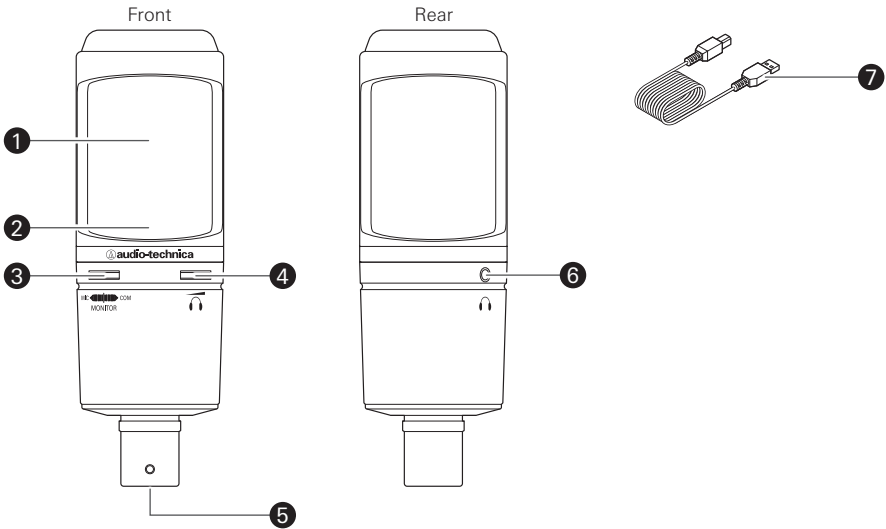

**1** Microphone

**2** Indicator lamp

Lights blue to show that the microphone is receiving power via USB.

**3** Mix control dial

Adjusts the balance of the volume level of the sound source stored on the computer and the monitored volume level of the audio being input.

**4** Headphone level control dial

Adjusts volume of headphone output.

**5** USB terminal (USB Type-B)

Use to connect the included USB cable.

**6** Headphone jack

(3.5 mm (1/8") stereo mini-jack)

Use to connect the headphones.

**7** USB cable

(3.1 m (10'), USB Type-A - USB Type-B)

---

## Setting up the product

---

For best results, set up the microphone so that it is facing the sound source. When using it to record voices, place it directly in front of the speaker/singer. Do the same thing when recording sound sources such as acoustic guitar, drums, or piano. Before using the product, try setting it up in various positions, to discover how best to record sound in your current environment.

---

## Connection procedure

---

1. Connect the USB cable (USB Type-B side) to the USB terminal on the underside of the product.
2. Connect the USB cable (USB Type-A side) to the computer.
  - If you are using Windows, refer to "Computer settings (Windows 8.1/10)" on p.5 to do the settings.
  - If you are using Mac, refer to "Computer settings (Mac OS X)" on p.9 to do the settings.

# Using the product

## Computer settings (Windows 8.1/10)

1. Use the USB cable to connect the product to a computer.
2. Confirm that the indicator lamp on the product lights.
  - Indicator lamp lights blue to show that the microphone is receiving power via USB.
  - The computer automatically recognizes the product and the driver is installed on the computer.
  - In the lower right part of the screen, a message appears indicating that new hardware has been found or a notification appears that the driver software has been installed.
3. Open the "Control Panel".
  - For Windows 10  
Select "Start menu" > "Windows System" > "Control Panel".

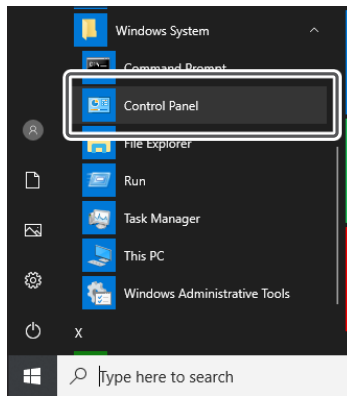

# Using the product

- For Windows 8.1  
Right click "Start Menu", and select "Control Panel".

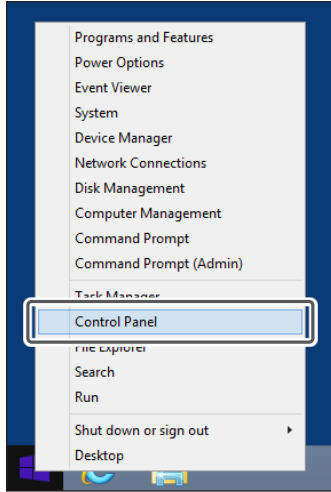

4. Select "Sound".

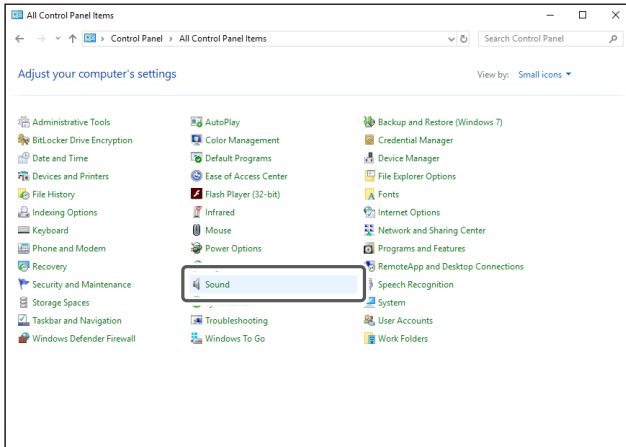

# Using the product

5. In the "Playback" tab, confirm that the product is selected.
- If the product is not selected, select the product, and then click "Set Default".

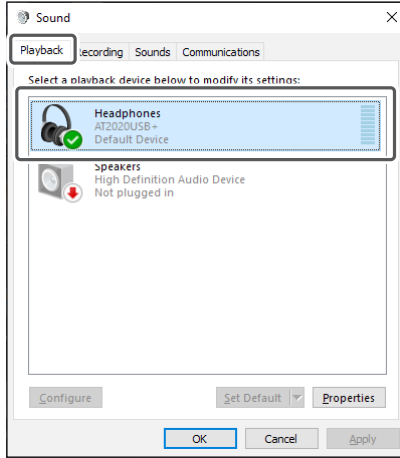

6. In the "Recording" tab, confirm that the product is selected.
- If the product is not selected, select the product, and then click "Set Default".

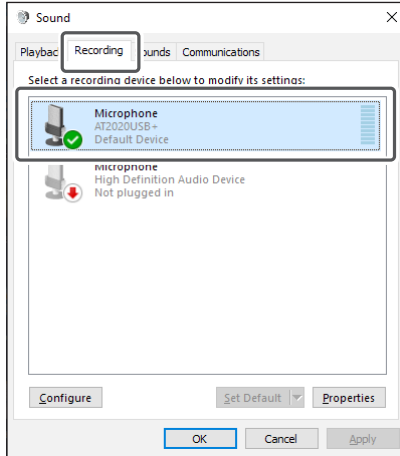



# Using the product

7. Double-click the product's icon, and open the "Microphone Properties" window.
8. Select the "Levels" tab to adjust the microphone level.
  - To adjust the microphone level after you start recording, do the adjustments from this window.

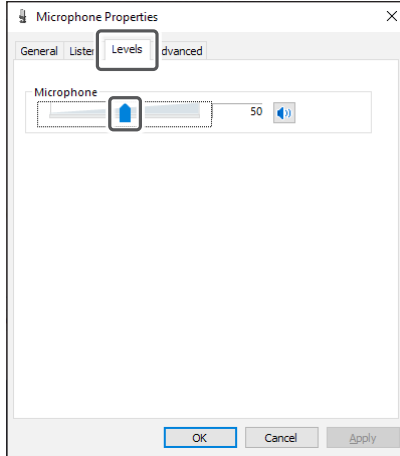

# Using the product

## Computer settings (Mac OS X)

1. Use the USB cable to connect the product to a computer.
2. Confirm that the indicator lamp on the product lights.
  - Indicator lamp lights blue to show that the microphone is receiving power via USB.
  - The computer automatically recognizes the product and the driver is installed on the computer.
3. From the Apple icon, select "System Preferences".

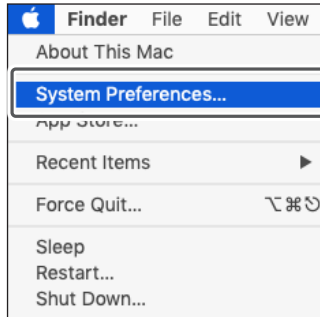

4. Select "Sound".



# Using the product

5. In the "Input" tab, select the product.

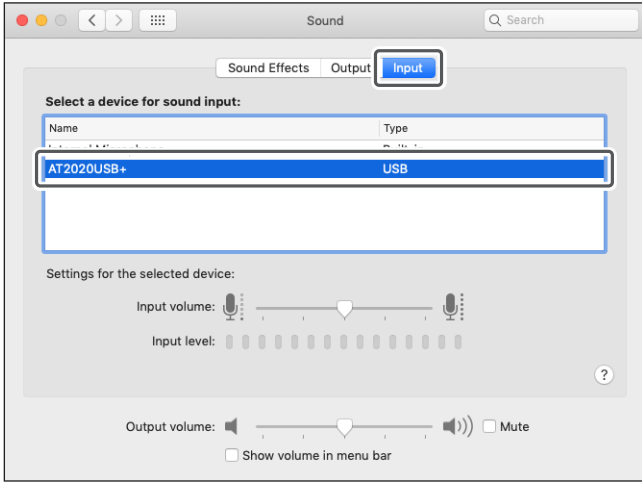

6. In the "Output" tab, select the product.

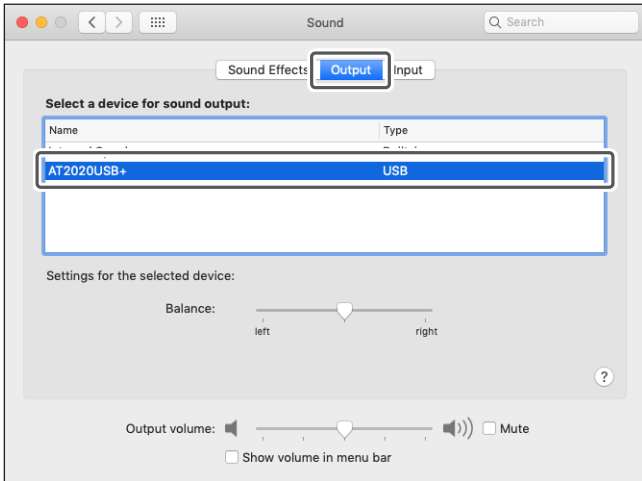

## Using the product

### Microphone orientation

To use the product, face towards the side that has the Audio-Technica logo while speaking.

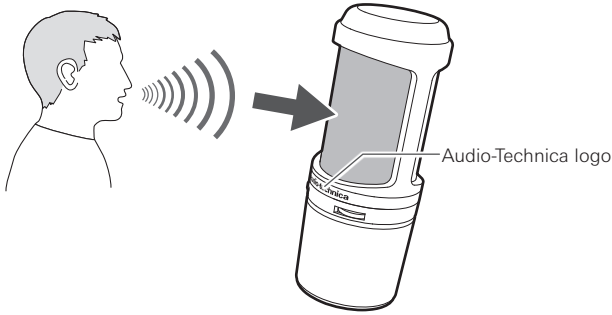

### Using software for recording

Software for recording is not included with the product. To use the product to record audio, use commercially available recording software. You may need to set up the recording software, such as by setting the audio input and output. For details, see the User Manual for the recording software.

### Adjusting the microphone level

To get the best performance, you need to appropriately adjust the microphone level of the product. When using the product, set the microphone level of the product as high as possible, in a range that does not put an excessive load on the computer. If the sound is distorted, or the recording software you are using is always at peak levels, then decrease the microphone level of the product in the settings on the control panel (system preferences for Mac OS) or the settings for the recording software you are using.

If you feel that the product's microphone level is insufficient, then increase the microphone level of the product in the settings on the control panel (system preferences for Mac OS) or the settings for the recording software you are using. After that, you do not need to adjust the microphone level of the product, unless the volume of the sound source varies greatly.

# Using the product

## Connecting and using the headphones

You can monitor sounds being recorded by connecting headphones to the headphone jack. Also, you can directly monitor your own voice from the product while listening to a sound source from your computer.

1. Connect the headphones to the headphone jack.
2. Turn the headphone level control dial to adjust the volume.

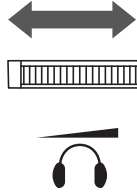

- The headphone level control dial adjusts the volume of the headphone output; it does not adjust the microphone level.

## Using the mix control dial

The product allows you to monitor your own voice from the product while listening to a sound source from your computer. You can use the mix control dial to adjust the balance of the volume level of the sound source stored on the computer and the monitored volume level of the audio being input.

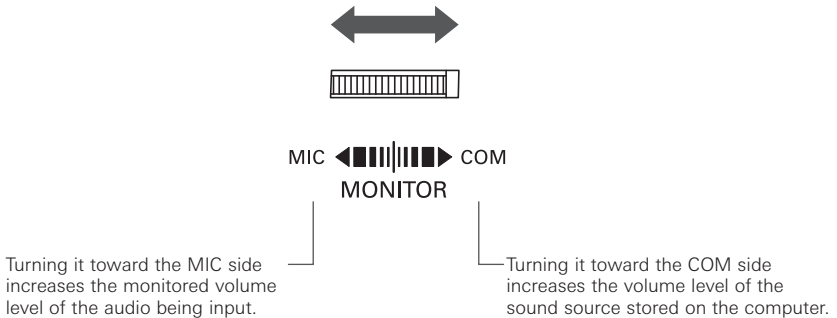

## Cleaning

Regularly clean the product to ensure that it will last for a long time. Do not use alcohol, paint thinners, or other solvents for cleaning purposes.

- Wipe dirt off the product with a dry cloth.
  - If the cables become dirty because of sweat, etc., wipe them with a dry cloth immediately after use. Failure to clean the cables may cause them to deteriorate and harden over time, resulting in a malfunction.
- If the product will not be used for an extended period of time, store it in a well-ventilated place free from high temperatures and humidity.

## Dimensions

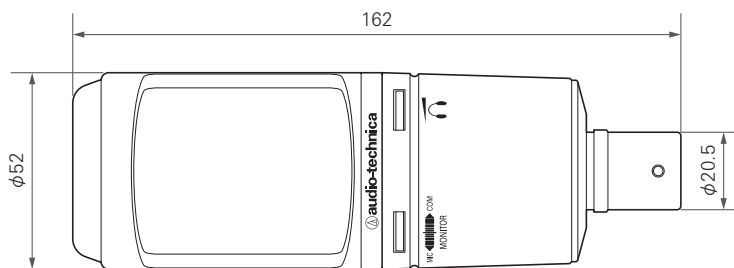

(Unit: mm)

## Specifications

System requirements	USB 1.0 or 2.0, and 64 MB or more of RAM
Supported OS	Windows 8.1, Windows 10, and Mac OS X or later (Please check the product's web page for the latest information.)
Element	Fixed-charge back plate, permanently polarized condenser
Polar pattern	Cardioid
Frequency response	20-20,000 Hz
Power supply	USB power (5 VDC)
Bit depth	16 bit
Supported sampling rates	44.1 kHz/48 kHz
Controls	Headphone level control, Mix control
Dimensions	162 mm (6.38") long, 52 mm (2.05") maximum body diameter
Weight	About 386 g (13.6 oz)
Output connector	USB Type-B
Headphone output	130 mW (at 1 kHz, 10% T.H.D., 32 ohms)
Headphone jack	3.5 mm (1/8") stereo mini-jack
Included accessories	<ul style="list-style-type: none"><li>• Pivoting stand mount for 5/8"-27 threaded stands</li><li>• 5/8"-27 to 3/8"-16 threaded adapter</li><li>• Soft protective pouch</li><li>• Tripod desk stand</li><li>• 10' (3.1 m) USB cable</li></ul>

For product improvement, the product is subject to modification without notice.

# Specifications

## Polar pattern

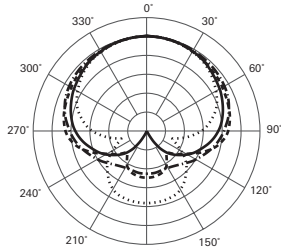

SCALE IS 5 DECIBELS PER DIVISION

### LEGEND

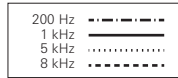

## Frequency response

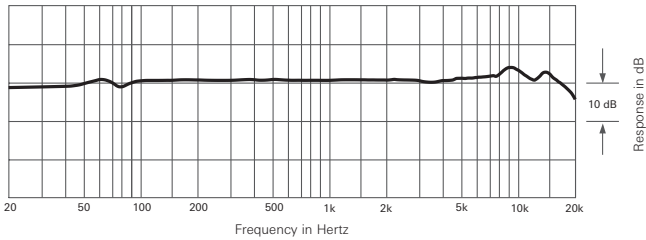

### LEGEND

