

Vinyl Styl™



MODEL: SW-196B

**3-Speed Stereo Turntable
With Built-in Speakers**



WARNINGS

- To reduce the risk of fire or electric shock, do not expose this appliance to rain or moisture.
- To reduce the risk of electric shock, do not open the cabinet. No user serviceable parts are inside. Refer servicing to qualified personnel.
- Caution: Do not expose this appliance to dripping or splashing liquids. Do not put objects filled with liquid, such as vases on or near the appliance.
- Caution: To turn this appliance off completely, the POWER cord must be unplugged from the wall outlet. The power cord must be easily accessible at all times.

 <p>THE LIGHTNING FLASH WITH ARROWHEAD SYMBOL, WITHIN AN EQUILATERAL TRIANGLE, IS INTENDED TO ALERT THE USER TO THE PRESENCE OF NON-INSULATED "DANGEROUS VOLTAGE" WITHIN THE PRODUCT'S ENCLOSURE THAT MAY BE OF SUFFICIENT MAGNITUDE TO CONSTITUTE A RISK OF ELECTRIC SHOCK TO PERSONS.</p>	<p>CAUTION RISK OF ELECTRIC SHOCK DO NOT OPEN</p> <p>WARNING: TO REDUCE THE RISK OF ELECTRIC SHOCK, DO NOT REMOVE THE FRONT OR REAR COVER. NO USER SERVICEABLE PARTS ARE INSIDE. REFER SERVICING TO QUALIFIED SERVICE PERSONNEL.</p>	 <p>THE EXCLAMATION POINT WITHIN AN EQUILATERAL TRIANGLE IS INTENDED TO ALERT THE USER TO THE PRESENCE OF IMPORTANT OPERATING AND MAINTENANCE (SERVICING) INSTRUCTIONS IN THE LITERATURE ACCOMPANYING THE APPLIANCE.</p>
--	--	---

FCC WARNINGS

WARNING: Changes or modifications to this unit not expressly approved in this manual could void the user's authority to operate the equipment.

NOTE: This equipment has been tested and found to comply with the limits for a Class B digital device, pursuant to Part 15 of the FCC Rules. These limits are designed to provide reasonable protection against harmful interference in a residential installation. This equipment generates, uses, and can radiate radio frequency energy and, if not installed and used in accordance with the instructions, may cause harmful interference to radio communications. However, there is no guarantee that interference will not occur in a particular installation. If this equipment does cause harmful interference to radio or television reception, which can be determined by turning the equipment off and on, the user is encouraged to try to correct the interference by one or more of the following measures:

- Reorient or relocate the receiving antenna.
- Increase the separation between the equipment and receiver.
- Connect the equipment into an outlet on a circuit different from that to which the receiver is connected.
- Consult the dealer or an experienced radio/TV technician for help.

IMPORTANT SAFETY INSTRUCTIONS

- 1) Read these instructions.
- 2) Keep these instructions.
- 3) Heed all warnings.
- 4) Follow all instructions.
- 5) Do not use this apparatus near water.
- 6) Clean only with dry cloth.
- 7) Do not block any ventilation openings. Install in accordance with the manufacturer's instructions.
- 8) Do not install near any heat sources such as radiators, heat registers, stoves, or other apparatus (including amplifiers) that produce heat.
- 9) Do not defeat the safety purpose of the polarized or grounding-type plug. A polarized plug has two blades with one wider than the other. A grounding type plug has two blades and a third grounding prong. The wide blade and/or the third prong are provided for your safety. If the provided plug does not fit into your outlet, consult an electrician for replacement of the obsolete outlet.
- 10) Protect the POWER cord from being walked on or pinched particularly at plugs, convenience receptacles, and the point where they exit from the apparatus.
- 11) Only use attachments/accessories specified by the manufacturer.
- 12) Use only with the cart, stand, tripod, bracket, or table specified by the manufacturer, or sold with the apparatus. When a cart is used, use caution when moving the cart/apparatus combination to avoid injury from tip-over.
- 13) Unplug this apparatus during lightning storms or when unused for long periods of time.
- 14) Refer all servicing to qualified service personnel. Servicing is required when the apparatus has been damaged in any way, such as POWER-supply cord or plug is damaged, liquid has been spilled or objects have fallen into the apparatus, the apparatus has been exposed to rain or moisture, does not operate normally, or has been dropped.



COMPONENT IDENTIFICATION

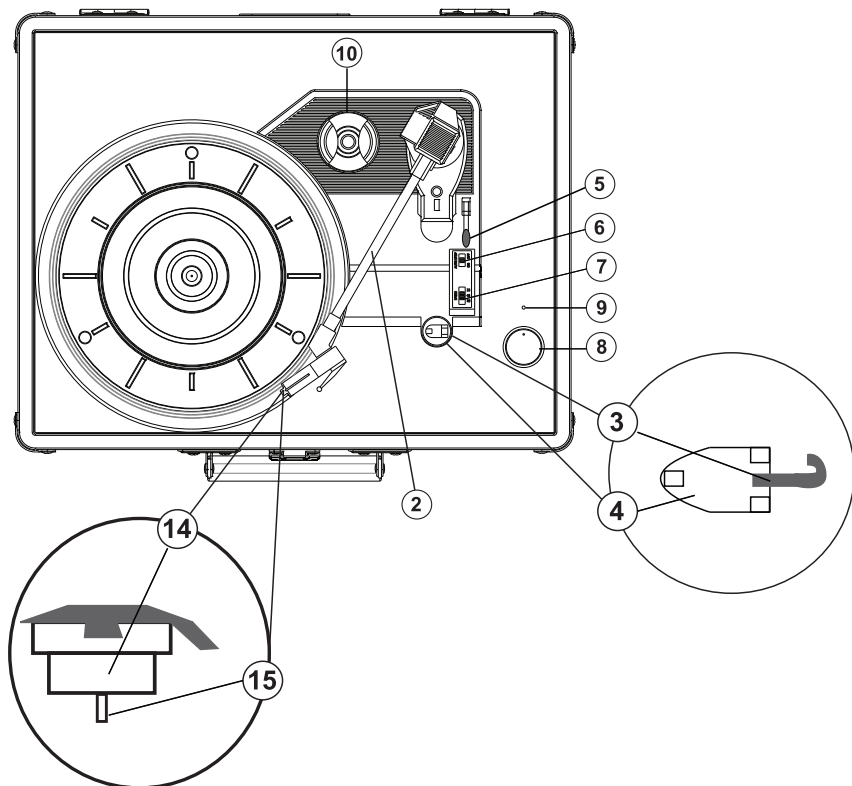
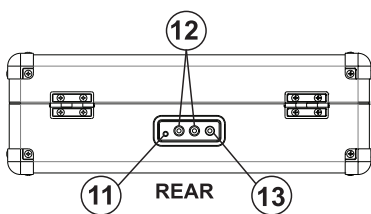
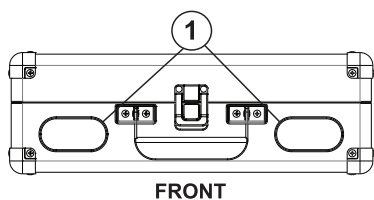

- | | |
|-----------------------------|---|
| 1. SPEAKERS | 9. POWER INDICATOR LIGHT |
| 2. TONEARM | 10. 45 RPM ADAPTER |
| 3. TONEARM LOCK | 11. 3.5mm HEADPHONE JACK |
| 4. TONEARM REST | 12. AUDIO OUTPUTS (Standard RCA Red & White) |
| 5. TONEARM LEVER | 13. AC 100-240V, 50/60HZ to DC 5V, 0.5A INPUT |
| 6. AUTO STOP CONTROL SWITCH | 14. CARTRIDGE |
| 7. SPEED CONTROL SWITCH | 15. STYLUS (NEEDLE) |
| 8. POWER-VOLUME KNOB | |

UNPACKING YOUR TURNTABLE

1. Carefully remove the turntable and accessories from the box.
2. Place the turntable on a flat, level surface and carefully open the lid.
3. Remove the white protective Stylus Cover by gently pulling it away from the TONEARM (2) as shown below.
4. Carefully remove the twist-tie from the TONEARM (2).

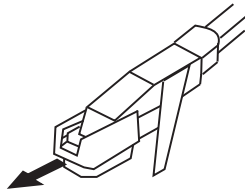

5. Release the TONEARM LOCK (3) holding the TONEARM (2) to the TONEARM REST (4) by gently pushing the TONEARM LOCK (3) to the right.
 - **NOTE:** Please do not discard the white protective stylus cover as it can protect the stylus when the turntable is not in use or is being moved.

POWER

1. Plug the supplied AC 100-240V, 50/60HZ to DC 5V, 0.5A power adapter into the AC 100-240V, 50/60HZ to DC 5V, 0.5A INPUT (13) located on the rear of the turntable.
2. Insert the wall plug of the power adapter into an electrical wall outlet.
3. Turn the Turntable ON by turning the **POWER/VOLUME KNOB (8)** clockwise.
 - **NOTE:** You will hear a click when the knob is first turned to the right and the **POWER INDICATOR LIGHT (9)** turns ON.
4. Turn the Turntable OFF by turning the **POWER/VOLUME KNOB (8)** counterclockwise until you hear the click which indicates the power is OFF and the **POWER INDICATOR LIGHT (9)** turns OFF.

VOLUME

The Speaker Volume is also controlled by the **POWER/VOLUME KNOB (8)**.

- To Increase the Volume: Turn the **POWER/VOLUME KNOB (8)** clockwise.
- To Decrease the Volume: Turn the **POWER/VOLUME KNOB (8)** counterclockwise.

PLAYING A RECORD

1. Set the **SPEED CONTROL SWITCH (7)** to the correct speed for your record (33 $\frac{1}{3}$, 45, or 78 RPM).
2. Place the record on the turntable being careful to place the spindle directly in the record hole.
 - We have included a 45 RPM ADAPTER (**10**) to use when playing 45 RPM records. Just pull the adapter from its convenient storage space next to the rear of the TONEARM and place it over the spindle.
3. Unlock the TONEARM LOCK (**3**) by gently pushing the Lock to the right and the TONEARM (**2**) will be ready for play.
 - **CAUTION:** Always lock the TONEARM (**2**) in place using the TONEARM LOCK (**3**) when the player is not in use or the turntable is being moved. Failure to do so can cause damage to the cartridge or stylus.
4. Turn the **POWER/VOLUME KNOB (8)** clockwise to turn the Player ON.
5. Adjust the Volume to the desired level by turning the **POWER/VOLUME KNOB (8)**.
6. Raise the TONEARM (**2**) by slowly lifting the TONEARM LEVER (**5**).
7. Using your finger move the TONEARM (**2**) over the portion of the record you want to hear. The record automatically begins spinning once the TONEARM (**2**) is over the record surface.
8. Lower the TONEARM (**2**) using the TONEARM LEVER (**5**) until the STYLUS (**15**) touches the record and begins playing your music. Make sure the TONEARM LEVER (**5**) is completely down.
9. When finished listening, use the TONEARM LEVER (**5**) to raise the TONEARM (**2**) and then place it back on the TONEARM REST (**4**). The record will automatically stop spinning.
10. If finished using the Turntable, be sure to lock the TONEARM LOCK (**3**).

AUTO STOP

The AUTO STOP feature allows the turntable to automatically stop playing when the STYLUS (15) reaches the end of the record.

- To turn the AUTO STOP feature ON: Set the **AUTO STOP CONTROL SWITCH (6)** to AUTO.
- To turn the AUTO STOP feature OFF: Set the **AUTO STOP CONTROL SWITCH (6)** to MANUAL.
 - **NOTE:** When using the MANUAL setting, once the record is finished the player will continue to spin until you raise the TONEARM (2) and move it back to the TONEARM REST (4) which stops the spinning.

CONNECTING THE TURNTABLE TO AN EXTERNAL SPEAKER OR STEREO SOURCE

Use the included Red & White RCA Cables to connect the turntable to an External Speaker or Stereo system. Simply plug the Red & White ends of the RCA Cable into the corresponding Red & White AUDIO OUTPUT JACKS (12) on the rear of the player. Then connect the other Red & White ends of the RCA Cable into the corresponding Red & White Audio Input Jacks on your External Speakers or Stereo system.

LISTENING TO THE TURNTABLE WITH HEADPHONES

To use Headphones with this player, connect any headphone with a 3.5mm jack into the input on the 3.5mm HEADPHONE JACK (11) located on the rear of the player.

- **NOTE:** When headphones are plugged in, no sound will be heard from the built-in speakers.

REMOVING THE STYLUS (NEEDLE)

NOTE: IF NOT DONE CORRECTLY, SEPARATING THE STYLUS FROM THE CERAMIC CARTRIDGE CAN CAUSE DAMAGE TO THE CARTRIDGE. IF NEEDED, PLEASE SEEK ASSISTANCE FROM AN EXPERIENCED INDIVIDUAL.

1. Lock the TONEARM (2) on the TONEARM REST (4) by pushing the TONEARM LOCK (3) to the left.

2. Remove the white protective Stylus Cover (if necessary).

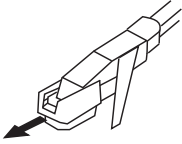

3. Hold the bottom of the CARTRIDGE (14) with your thumb & index finger as shown below in Fig. 3a. With your other thumb carefully push down on the top edge of the the Red Stylus Assembly (Red piece includes the needle) until the Stylus Assembly separates from the CARTRIDGE (14) as shown in Fig 3b.

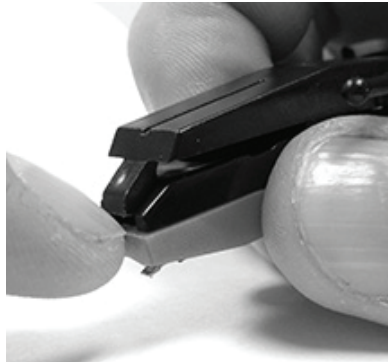

FIG 3a



FIG 3b

4. Carefully remove the entire Stylus Assembly from the Cartridge by pulling the Stylus Assembly away from the CARTRIDGE (14) (fig 4a).



FIG 4a

INSTALLING THE NEW STYLUS (NEEDLE)

NOTE: DO NOT DIRECTLY TOUCH THE STYLUS (NEEDLE) (15) DURING INSTALLATION, OR YOU MAY CAUSE PERMANENT DAMAGE TO THE STYLUS (15).

1. Hold the front tip of the Stylus Assembly with your thumb and index finger and insert the rear edge of the Stylus Assembly on the CARTRIDGE (14) as shown in Fig 5a.

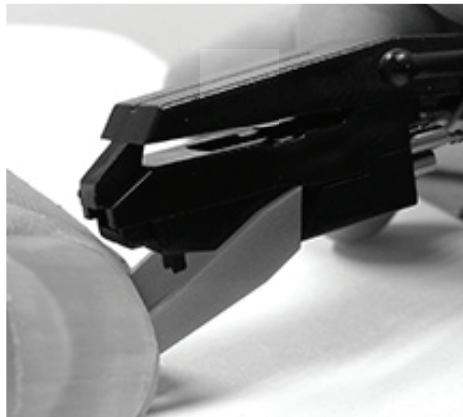

FIG 5a

2. While applying gentle pressure on the top of the TONEARM (2) with your index finger, carefully push the Stylus Assembly upwards until you hear a click and the Stylus Assembly locks into place (Fig 6a).



FIG 6a

3. The new STYLUS (15) is now ready to use.



FIG. 7a: A CORRECTLY POSITIONED STYLUS

- Under normal use a STYLUS (15) should last for about 50-60 hours of record play. It is recommended the STYLUS (15) be replaced as soon as you notice a deterioration of the sound quality.
- Use of a worn out STYLUS (15) may damage records.
- Playing 78 RPM records will cause the STYLUS (15) to wear out much faster than $33\frac{1}{3}$ or 45 RPM records.
- A replacement STYLUS (15) can be purchased by going to www.VinylStyl.com

TROUBLESHOOTING

MUSIC SOUNDS TOO SLOW OR TOO FAST

- Check to confirm the **SPEED CONTROL SWITCH (7)** is correctly set for the record being played (33 $\frac{1}{3}$, 45, or 78 RPM).

RECORDS KEEP SKIPPING

- Carefully look at the surface of the record under a strong light to see if there are any significant scratches or other damage to the record which will cause it to skip.
- Make sure the turntable is on a flat level surface.
- Clean the record with a Vinyl Styl™ record cleaning brush to remove build up of dust & dirt in the grooves of the record
- Choose a different record after examining it to be sure the record is clean to see if you're get the same result.
- Check to make sure the **STYLUS (15)** is in the correct middle position.
- Check to make sure the **STYLUS (15)** is not bent or broken by lightly touching the tip of the diamond needle. If a replacement **STYLUS (15)** is needed please go to www.VinylStyl.com

NO SOUND

- Make sure the white protective Stylus Cover has been removed from the cartridge.
- Increase the volume by turning the **POWER/VOLUME KNOB (8)** clockwise as it may be set too low.
- Confirm there is nothing plugged into the 3.5mm **HEADPHONE JACK (11)** on the rear of the player.
- Check the position of the **STYLUS (15)** to insure it has not shifted out of its proper middle position (See Fig. 7a on page 9).

NO POWER

- Make sure the AC 100-240V, 50/60HZ to DC 5V, 0.5A power adapter is securely connected to the AC 100-240V, 50/60HZ to DC 5V, 0.5A **INPUT (13)** on the rear of the turntable as well as the wall outlet.
- Make sure the electrical outlet is working by plugging in another device.

If the tips above do not solve the problem you are experiencing please go to www.VinylStyl.com



LIMITED 90-DAY WARRANTY

We warrant this product to be free from defects in material and workmanship under normal use for a ninety-day period from the original date of purchase from an authorized Vinyl Styl™ dealer.

Should you be missing any of the included accessories or other components (screws, pieces, etc.), please go to www.VinylStyl.com to secure a replacement. It is not necessary to bring the unit back to the store. When calling, please reference the parts list found in the Instruction Manual to help us accurately identify the missing parts and promptly provide replacements.

We will replace the unit free of charge should it become defective under this warranty, providing you, the original purchaser, have your original dated sales receipt.

To obtain warranty service or replacement within the ninety-day warranty period, please return the product with all parts and accessories along with your original dated store receipt to the original place of purchase and the unit will be exchanged at no charge. It is not necessary to contact the manufacturer for warranty replacement.

For any and all customer support, technical assistance and troubleshooting please visit www.VinylStyl.com.

This warranty applies only under conditions of normal use. Our products are not intended for outdoor use.

There are no consumer serviceable electronic parts contained in this product and any attempt by the owner to service or repair the unit will immediately void all warranty coverage. The purchaser of this product does have the ability to remove and replace a worn or damaged stylus without voiding warranty coverage.

This warranty does not cover any product which has been subject to damage due to an act of nature, misuse, neglect, accident, abuse, commercial use, or modification of, or to, any part of the product, including the antenna. Damage to any external media such as records, and/or other media are not covered nor is the cost incurred in shipping the unit for warranty repair or exchange. Under no circumstances shall Vinyl Styl™ be liable for any loss (direct, indirect, incidental, foreseen, unforeseen, special or consequential) or for any damage arising out of, or in connection with, the use of this product.

UNDER NO CIRCUMSTANCES WILL VINYL STYL™ BE LIABLE FOR ANY INCIDENTAL OR CONSEQUENTIAL DAMAGES.

This warranty does not cover re-manufactured, refurbished, or repaired units, or any products sold 'As Is'.

This warranty is valid only to the original purchaser of the Product in the United States and Canada and grants specific legal rights.



VINTAGE SOLUTIONS FOR THE MODERN ERA

Introducing Vinyl Styl™, an exclusive line of products specifically developed to enhance the value of your LP listening experience. Using yesterday's ethics of quality care to successfully design superior LP treatment products is essential for today's vinyl culture. Vinyl Styl™ provides the highest level of sustainability for your records and accessories, while most importantly remaining affordable.

Protect your collection with Vinyl Styl™ today.



**ANTI-STATIC
RECORD BRUSH**



RECORD CLEANING FLUID



**ANTI-STATIC
STYLUS CLEANER**

**DEEP CLEANING
SYSTEM**



ALSO AVAILABLE
50 PROTECTIVE OUTER RECORD
SLEEVES - 12.75" x 12.75"

100 PROTECTIVE OUTER RECORD
SLEEVES - 12.75" x 12.75"

50 PROTECTIVE OUTER RECORD
SLEEVES - 7 9/16" x 7 5/8"

100 PROTECTIVE OUTER RECORD
SLEEVES - 7 9/16" x 7 5/8"

WWW.VINYLSYDL.COM