

Soundcraft[®] Signature

User Guide

For Soundcraft Signature 16, 22 & 22MTK



Soundcraft[®]
by HARMAN



INFORMATION



IMPORTANT

Please read this manual carefully before using your mixer for the first time.

This equipment complies with the EMC directive 2004/108/EC and LVD 2006/95/EC.

This product is approved to safety standards:
IEC 60065:2005 (Seventh Edition) +A1:2005
EN60065:2006 +A1:2006 +A1:2008
UL60065 2012 7th Edition
CAN/CSA-E60065-03 + A1: 2006
And EMC standards
EN55103-1: 2009 (E2)
EN55103-2: 2009 (E2)

Warning: Any modification or changes made to this device, unless explicitly approved by Harman, will invalidate the authorisation of this device. Operation of an unauthorised device is prohibited under Section 302 of the Communications act of 1934, as amended, and Subpart 1 of Part 2 of Chapter 47 of the Code of Federal Regulations.

NOTE: This equipment has been tested and found to comply with the limits for a Class B digital device, pursuant to Part 15 of the FCC Rules. These limits are designed to provide reasonable protection against harmful interference in a residential installation. This equipment generates, uses and can radiate radio frequency energy and, if not installed and used in accordance with the instructions, may cause harmful interference to radio communications. However, there is no guarantee that interference will not occur in a particular installation. If this equipment does cause harmful interference to radio or television reception, which can be determined by turning the equipment off and on, the user is encouraged to try to correct the interference by one or more of the following measures:

- * Reorient or relocate the receiving antenna
- * Increase the separation between the equipment and the receiver
- * Connect the equipment into an outlet on a circuit different from that to which the receiver is connected.
- * Consult the dealer or an experienced radio/TV technician for help.

For further details contact: Harman International Industries Ltd, Cranbourne House, Cranbourne Road, Potters Bar, Hertfordshire EN6 3JN, UK. Telephone +44 (0)1707 665000 Fax: +44 (0)1707 660742 email: soundcraft@harman.com

© Harman International Industries Ltd. 2014 All rights reserved
Parts of the design of this product may be protected by worldwide patents.
Part No. 5056808
Rev 1.0
E&OE September 2014

Soundcraft is a trading division of Harman International Industries Ltd. Information in this manual is subject to change without notice and does not represent a commitment on the part of the vendor. Soundcraft shall not be liable for any loss or damage whatsoever arising from the use of information or any error contained in this manual. No part of this manual may be reproduced, stored in a retrieval system, or transmitted, in any form or by any means, electronic, electrical, mechanical, optical, chemical, including photocopying and recording, for any purpose without the express written permission of Soundcraft.

Harman International Industries Limited
Cranborne House, Cranborne Road, Potters Bar, Hertfordshire, EN6 3JN, UK
Tel: +44 (0)1707 665000
Fax: +44 (0)1707 660742
<http://www.soundcraft.com>

CONTENTS

1.0 AN INTRODUCTION TO SIGNATURE

- 1.0.1 The Signature Legacy
- 1.0.2 Sapphire Asymmetric EQ

- 1.1: Safety
- 1.2: Warranty
- 1.3: Specifications

2.0: GETTING STARTED

- 2.1: Introduction To Consoles
- 2.2: Parts Of The Console

3.0: INPUTS AND OUTPUTS

- 3.1: Introduction to I/O
- 3.2: Console Inputs
- 3.3: Console Outputs
- 3.4: Other I/O

4.0: CONSOLE ROUTING

- 4.1: Mono Input Channel
- 4.1: Stereo Input Channel
- 4.3: FX Return Channel
- 4.4: Aux Master Output
- 4.5: Group Master Output
- 4.6: Master Stereo Output

5.0: CHANNEL CONTROLS

- 5.1: Input Controls
 - 5.1.1: Mono Input Controls
 - 5.1.2: Stereo Input Controls
 - 5.1.3: FX Return Controls
- 5.2: Aux Master Controls
- 5.3: Group Master Controls
- 5.4: Master Stereo Controls

6.0: SOLO AND MONITORING

7.0: USB OPERATION

- 7.1: Signature 16, 22 USB
- 7.2: Signature 22MTK USB

8.0: LEXICON FX

- 8.1: FX Control
- 8.2: Reverbs
- 8.3: Delays And Modulation

APPENDIX 01: NO SOUND?

For clarity, this manual uses section references rather than page numbers. In some instances, one section reference may extend to several pages.

INTRODUCTION TO SIGNATURE

Drawing on over 40 years experience in live sound mixing, the Signature Series combines a superb analogue control surface with the unrivalled British sound of Soundcraft in a powerful, compact, professionally spec'd mixer.

Built tough for trouble-free performance night-after-night, Signature Series mixers deliver great sounding results thanks to high-grade Ghost® preamps, the most musical EQ in the business, pristine Lexicon® effects and powerful dbx® dynamics - all designed to let you discover your Signature sound.



• **Soundcraft® Ghost Mic Preamps**

Class-leading performance, with high headroom, wide dynamic range and superb signal to noise ratio.

• **Soundcraft® Sapphyre British EQ**

Famed for its musical sound and unmistakable 'British' quality

• **Soundcraft® GB audio routing**

Flexible pre/post switching on each Aux and subgroups with powerful routing and switching options as well as dedicated outputs.

• **dbx® Limiters**

High performance, high-ratio Compressors on selected input channels.

• **Hi-Z instrument inputs**

Switchable input stage, optimised for acoustic guitars, electric guitars, and basses.

• **Award-winning Lexicon® effects**

Studio-grade Reverbs, Delays, Choruses and Modulations, designed to add a truly professional edge to your productions.

• **USB Digital Audio**

USB digital I/O for direct connection to Digital Audio Workstations and digital systems. Signature MTK version adds Multi-Track functionality.

• **Playback Channel Functions**

'Interval Mute' fast switching of playback channel to main outputs, plus in-dependant Pre/Post Aux switching.

• **Built tough for the long haul**

Robust metal construction and premium-quality components: Built to withstand the rigours of extensive use.

SIGNATURE LEGACY



The Signature Series consoles bring musicality, creativity, and technical excellence together, thanks not only to new technology and ideas, but also to a 40-year legacy of producing outstanding performance tools. This console incorporate classic analogue designs, approved by Engineers.



Ghost® pre-amps

The Soundcraft Ghost console's ProMic mic pre-amp is known for its ultra-low noise and high headroom, making high gain settings possible, without compromising signal integrity.

Sapphyre British EQ

The Soundcraft Sapphyre console Asymmetric EQ makes both creative and functional tonal shaping of your signal simple and intuitive. The EQ behaves differently in cut and boost, making tonal adjustments musical, and focusing cuts where they are needed. See section 1.0.2 for more detail.

GB Routing

The GB Console legacy is in Signature's signal routing. There is pre/post switching for all aux busses, plus flexible routing and dedicated outputs for sub-groups. See section 4 for more detail.

SAPPHYRE EQ

Soundcraft Sapphyre Asymmetric EQ

The Soundcraft Signature console uses a special Asymmetric EQ first developed for the renowned Soundcraft Sapphyre console. This EQ makes both creative and functional tonal shaping of your signal simple and intuitive - an EQ that works the way music does.

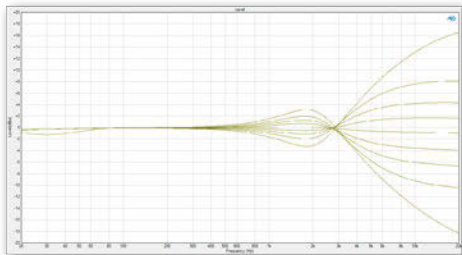
**HF - High Frequency Shelf**

A slight cut at boost prevents harsh resonance, and a slight boost at cut preserves brightness

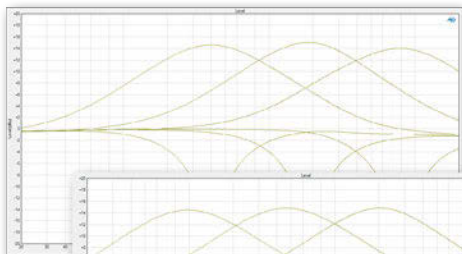
**LMF and HMF (Mid-band, bell shape)**

A wide boost prevents harsh resonance, and a narrow cut allows precision 'fixing'.

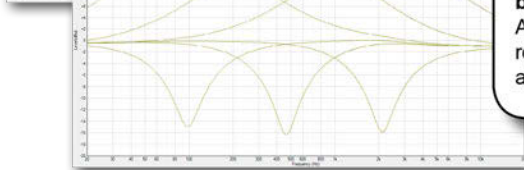
**LF - Low Frequency Shelf**

A slight cut at boost prevents muddiness, and a slight boost at cut preserves body.

The shelving bands of the EQ (LF and HF) use a slight boost at the EQ's frequency when cutting, and a slight cut when boosting.

For low frequencies, a slight cut when boosting prevents muddiness in the signal, while a slight boost when cutting enables you to clean up the low end without losing precious 'punch' and 'body' of the signal. For the HF shelf, a slight cut when boosting prevents harsh resonance at the EQ's frequency, and a slight boost before a cut can help maintain brightness while reducing HF.

The mid-bands (bell-shape) have a wide bandwidth (low Q) when boosting, and a narrower bandwidth (high Q) when cutting.

The wide boost prevents prevent harsh resonances and tonal-changes that allow for a more pleasing and musical EQ boost. The Narrow cut focuses on problematic frequencies, for getting rid of resonances, rings, hums, and preventing feedback. If this was too wide you could remove too much 'body', creating a thin sound.

SAFETY NOTICES

For your own safety and to avoid invalidation of the warranty please read this section carefully.

Important Symbols



Cautions

Alerts the user to the presence of important operating and maintenance (servicing) instructions in the literature accompanying the appliance.



Warnings

Alerts the user to the presence of uninsulated 'dangerous voltage' within the product's enclosure that may be of insufficient magnitude to constitute a risk of electric shock to persons.



THIS UNIT MUST BE EARTHED

Under no circumstances should the mains earth be disconnected from the mains lead.

The wires in the mains lead are coloured in accordance with the following code:

Earth: Green and Yellow (Green/Yellow - US)

Neutral: Blue (White - US)

Live (Hot): Brown (Black - US)

As the colours of the wires in the mains lead may not correspond with the coloured markings identifying the terminals in your plug, proceed as follows:

The wire which is coloured Green and Yellow must be connected to the terminal in the plug which is marked with the letter E or by the earth symbol.

The wire which is coloured Blue must be connected to the terminal in the plug which is marked with the letter N.

The wire which is coloured Brown must be connected to the terminal in the plug which is marked with the letter L.

Ensure that these colour codings are followed carefully in the event of the plug being changed.

This unit is capable of operating over a range of mains voltages as marked on the rear panel.

The internal power supply unit contains no user serviceable parts. Refer all servicing to a qualified service engineer, through the appropriate Soundcraft dealer.

WARNINGS

- **Read** these instructions.
- **Keep** these instructions.
- **Heed** all warnings.
- **Follow** all instructions.
- **Clean** the apparatus only with a dry cloth.
- **Do not** install near any heat sources such as radiators, heat resistors, stoves, or other apparatus (including amplifiers) that produce heat.
- **Do not** block any ventilation openings. Install in accordance with the manufacturer's instructions.
- **Do not** use this apparatus near water.
- **Do not** defeat the safety purpose of the polarized or grounding type plug. A polarized plug has two blades with one wider than the other. A grounding type plug has two blades and a third grounding prong. The wide blade or the third prong are provided for your safety. When the provided plug does not fit into your outlet, consult an electrician for replacement of the obsolete outlet.
- **Protect** the power cord from being walked on or pinched particularly at plugs, convenience receptacles and the point where they exit from the apparatus.
- **Only** use attachments/accessories specified by the manufacturer.
- **Unplug** this apparatus during lightning storms or when unused for long periods of time.
- **Refer** all servicing to qualified service personnel. Servicing is required when the apparatus has been damaged in any way such as power-supply cord or plug is damaged, liquid has been spilled or objects have fallen into the apparatus, the apparatus has been exposed to rain or moisture, does not operate normally, or has been dropped.
- **Use** only with the cart, stand, tripod, bracket, or table specified by the manufacturer, or sold with the apparatus. When the cart is used, use caution when moving the cart/apparatus combination to avoid injury from tip-over.
- **No** naked flame sources, such as lighted candles or cigarettes etc., should be placed on the apparatus.
- **No user serviceable parts.** Refer all servicing to a qualified service engineer, through the appropriate Soundcraft dealer.



- It is recommended that all maintenance and service on the product should be carried out by Soundcraft or its authorised agents. Soundcraft cannot accept any liability whatsoever for any loss or damage caused by service, maintenance or repair by unauthorised personnel.



- **WARNING:** To reduce the risk of fire or electric shock, do not expose this apparatus to rain or moisture. Do not expose the apparatus to dripping or splashing and do not place objects filled with liquids, such as vases, on the apparatus. No naked flame sources, such as lighted candles, should be placed on the apparatus.

- Ventilation should not be impeded by covering the ventilation openings with items such as newspapers, table cloths, curtains etc.

WARNINGS



ADVICE FOR THOSE WHO PUSH THE BOUNDARIES

Although your new console will not output any sound until you feed it signals, it has the capability to produce sounds which, when monitored through an amplifier or headphones, can damage hearing over time.

Please take care when working with your audio — if you are manipulating controls which you don't understand (which we all do when we are learning), make sure your monitors are turned down. Remember that your ears are the most important tool of your trade, look after them, and they will look after you.

Most importantly — don't be afraid to experiment to find out how each parameter affects the sound — this will extend your creativity and help.



NOTE: This equipment has been tested and found to comply with the limits for a Class A digital device, pursuant to Part 15 of the FCC Rules. These limits are designed to provide reasonable protection against harmful interference when the equipment is operated in a commercial environment. This equipment generates, uses and can radiate radio frequency energy and, if not installed and used in accordance with the instruction manual, may cause harmful interference to radio communications. Operation of this equipment in a residential area is likely to cause harmful interference in which case the user will be required to correct the interference at his own expense.

This Class A digital apparatus meets the requirements of the Canadian Interference-Causing Equipment Regulations.

Cet appareil numérique de la Classe A respecte toutes les exigences du Règlement sur le matériel brouilleur du Canada.



NOTE: The packaging, in which your console arrived, forms part of the product and must be retained for future use.

WARRANTY

1 Soundcraft is a trading division of Harman International Industries Ltd.

End User means the person who first puts the equipment into regular operation.

Dealer means the person other than Soundcraft (if any) from whom the End User purchased the Equipment, provided such a person is authorised for this purpose by Soundcraft or its accredited Distributor.

Equipment means the equipment supplied with this manual.

2 If within the period of twelve months from the date of delivery of the Equipment to the End User it shall prove defective by reason only of faulty materials and/or workmanship to such an extent that the effectiveness and/or usability thereof is materially affected the Equipment or the defective component should be returned to the Dealer or to Soundcraft and subject to the following conditions the Dealer or Soundcraft will repair or replace the defective components. Any components replaced will become the property of Soundcraft.

3 Any Equipment or component returned will be at the risk of the End User whilst in transit (both to and from the Dealer or Soundcraft) and postage must be prepaid.

4 This warranty shall only be available if:

- a) The Equipment has been properly installed in accordance with instructions contained in Soundcraft's manual.
- b) The End User has notified Soundcraft or the Dealer within 14 days of the defect appearing; and
- c) No persons other than authorised representatives of Soundcraft or the Dealer have effected any replacement of parts maintenance adjustments or repairs to the Equipment; and
- d) The End User has used the Equipment only for such purposes as Soundcraft recommends, with only such operating supplies as meet Soundcraft's specifications and otherwise in all respects in accordance Soundcraft's recommendations.

5 Defects arising as a result of the following are not covered by this Warranty: faulty or negligent handling, chemical or electro-chemical or electrical influences, accidental damage, Acts of God, neglect, deficiency in electrical power, air-conditioning or humidity control.

6. The benefit of this Warranty may not be assigned by the End User.

7. End Users who are consumers should note their rights under this Warranty are in addition to and do not affect any other rights to which they may be entitled against the seller of the Equipment.

INTRODUCTION > SPECIFICATIONS

TYPICAL SPECIFICATIONS

• **Frequency Response**

- Mic / Line In to any Output: +/-1.5dB, 20Hz-20kHz

• **T.H.D.**

- Mono Mic Sensitivity -30dBu, Input level -16dBu, +14dBu @ Mix output: < 0.002% @ 1kHz

- Stereo Mic Sensitivity -30dBu, Input level -16dBu, +14dBu @ Mix output: < 0.007% @ 1kHz

• **Noise**

- Mono Mic Input E.I.N. (max gain): <-124dBu (150Ω source)

- Stereo Mic Input E.I.N. (max gain): <-124dBu (150Ω source)

• **Crosstalk (@ 1kHz)**

- Channel Mute: >-90dB

- Fader Cut-off (rel +10 mark): >-90dB

- Aux Send Pots Offness: >-82dB

EQ (Mono inputs)

- HF: 12kHz, +/-15dB

- HMF (swept): 400Hz – 8kHz, +/-15dB

- LMF (swept): 80Hz – 2kHz, +/-15dB

- LF: .60Hz, +/-15dB

EQ (Stereo inputs)

- HF: 12kHz, +/-15dB

- MF (swept): 140Hz - 3kHz, +/-15dB

- LF: 60Hz, +/-15dB

Power Consumption

- Signature 16: <80VA

- Signature 22: <100VA

- Signature 22MTK: <120VA

Operating Conditions

- Temperature Range: 5°C to 40°C

Input & Output Levels

- Mic Input: +12.5dBu max

- Line Input: >+26dBu max

- Stereo Inputs: >+26dBu max

- Mix Output: +21.5dBu max

- Headphones (@150Ω): 300mW

Input & Output Impedances

- Mic Input: 1.2kΩ

- Hi-Z Input: 968kΩ

- Line Input: 10kΩ

- Stereo Input: 21.5kΩ

- Outputs: 150Ω (balanced), 75Ω (unbalanced)

USB Audio (16, 22)

- Inputs/Outputs: 2-in, 2-out

- Bit Depth: 16-bit, 24-bit

- Sampling rate: 44.1kHz / 48kHz / 88.2kHz / 96kHz / 176.4kHz / 192kHz

Multi-channel USB Audio (22MTK)

- Inputs/Outputs: 24-in, 22-out

- Bit Depth: 16-bit, 24-bit

- Sampling rate: 44.1kHz / 48kHz

Net Weight

- Signature 16: 8.66kg

- Signature 22: 11.06kg

- Signature 22MTK: 11.36kg

Unit Dimensions (W × H × D)

- Signature 16: 630mm x 595mm x 210mm

- Signature 22: 750mm x 630mm x 210mm

- Signature 22MTK: 750mm x 630mm x 210mm

GETTING STARTED - AN INTRODUCTION TO THIS MANUAL

Anyone with minimal audio experience should be able to operate the Soundcraft Signature console without reading too much of this manual, though we do recommend you take the time to go through it. An excellent place to start would be the feature list on the introductory page (section 1.0), which will familiarise you with all of the main possibilities, facilities, and functions.

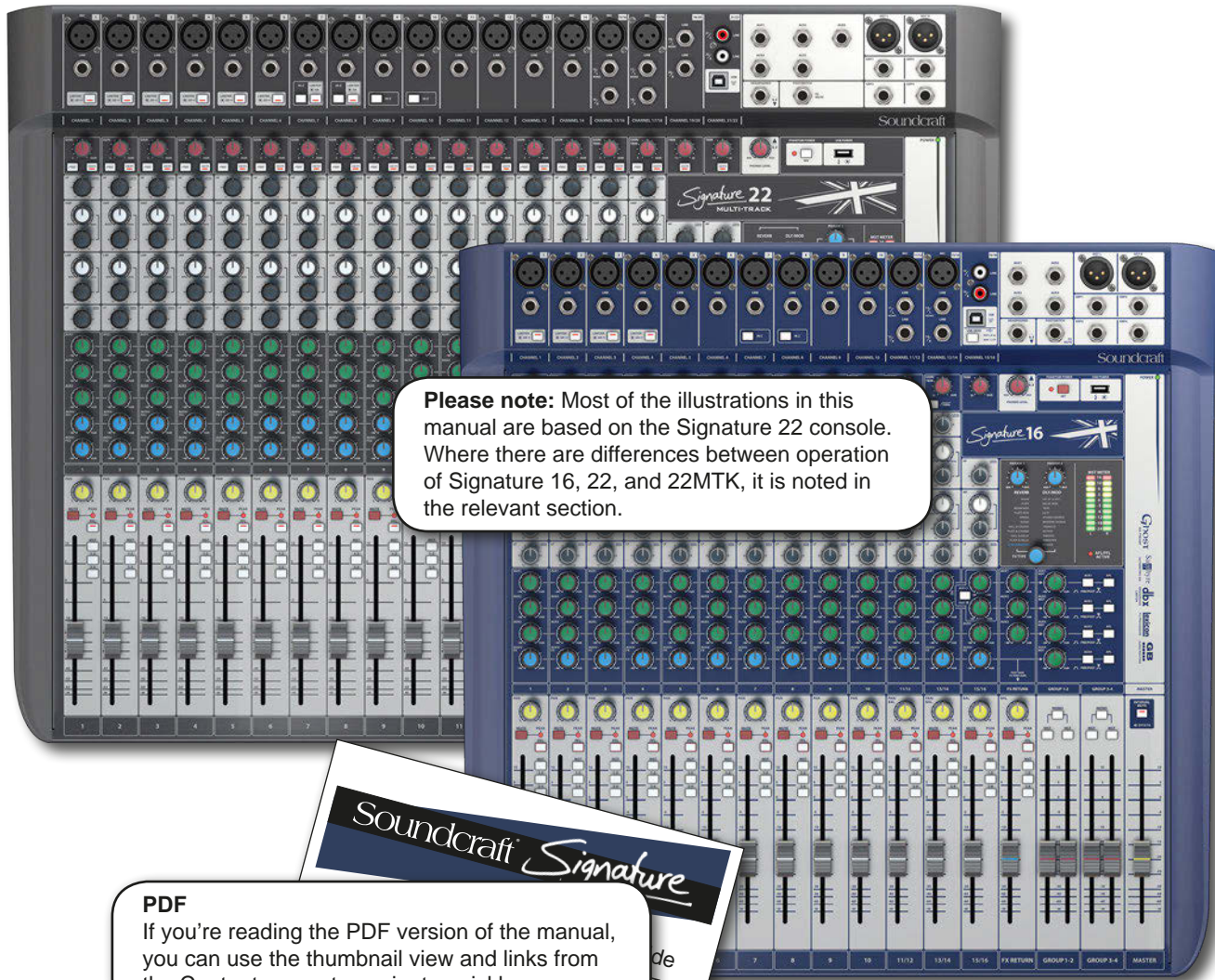

Please note: Most of the illustrations in this manual are based on the Signature 22 console. Where there are differences between operation of Signature 16, 22, and 22MTK, it is noted in the relevant section.

PDF

If you're reading the PDF version of the manual, you can use the thumbnail view and links from the Contents page to navigate quickly.

For clarity, this manual uses section references rather than page numbers. In some instances, one section reference may extend to several pages.



GETTING STARTED > INTRODUCTION TO MIXING CONSOLES

The main function of a mixing console is to combine different audio inputs and independently adjust the levels of those contributions to the mix. With this very basic functionality you can control and balance any kind of audio from a one-man-band to an orchestra.

Most mixers however (including the Signature Series) offer far more than that. A variety of features allow the operator to shape the mix, and use routing options to provide the additional conveniences used in audio mixing applications, such as external effects sends, stage monitoring outputs, independent headphone monitoring, and digital inputs and outputs.

Mix Faders

Faders make it easy to see and adjust relative levels. They allow you to visualise the mix.

Input Choice

All different microphones and instruments are catered for with mic, line, and Hi-Z input types / selections, including 48V phantom power for powered (condenser / capacitor) microphones. The gain control allows you to optimise the input level.

Equalisation

Examples include the high pass filter on an input to reduce unwanted low frequencies, or the three-band EQ (Equaliser) used for tonal 'shaping' of the source.

Dynamic Processing

This is audio processing that affects amplitude (volume). The Signature console includes a Limiter on selected channels, which will prevent the input signal going too high, which would in turn cause distortion.

Output options

As well as mixing all the input (source) channel into one Master Stereo output, you can send particular channels into additional group outputs, or create several different aux (auxiliary) mixes of all channels to send to an FX (Effects) processor or stage monitor, for example. The headphone output allows the operator to listen to the whole Main Mix, or to a selection of channels via the Solo System.

Solo / Monitor System

The solo system allows you to listen only to particular channels or busses through the headphones output, so you can focus on a particular source without changing the mix.

Internal FX

FX (Effects) processing such as reverb, delay, chorus, phasing, and so on can be incorporated into a mixing console so that you don't have to invest in 'outboard' equipment or use up valuable physical inputs and outputs. The Signature's Lexicon FX processing can be applied in a controlled manner by using the Auxiliary 3/FX mix and the dedicated stereo FX return channel.

Digital inputs and outputs.

Digital I/O is necessary to work with digital audio systems and computer-based Digital Audio Workstations. The Signature series uses a USB interface for either 2-channel input/output (main or Aux 1-2 output), or for multitrack input and output (MTK versions) with the USB inputs able to individually replace the input channel source for a flexible 'tape return' path. For example, the MTK functionality could use DAW plug-ins as insert processing on selected input channels, or you could do a sound check with a dry recording of the band from a previous gig... There are lots of ways to use this feature.

More Information

You can find out more about individual Signature features by reading the relevant section of this manual.

GETTING STARTED > PARTS OF THE CONSOLE

The diagrams show different sections of the Signature console and describes those functions. After that are more detailed descriptions of the console sections and references to the relevant chapters in this manual.

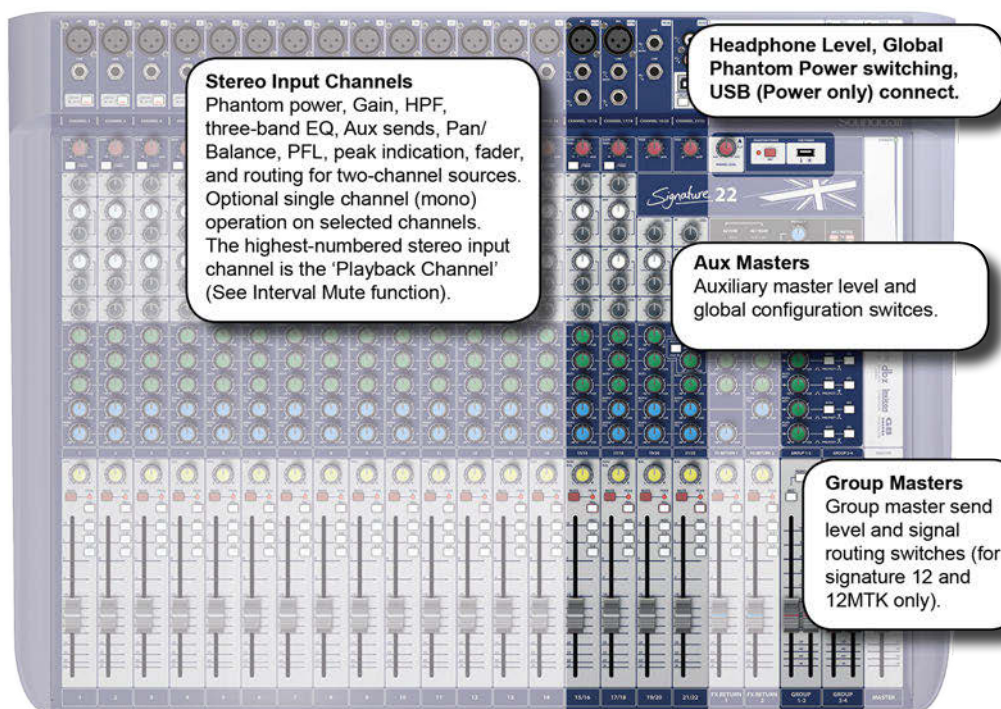
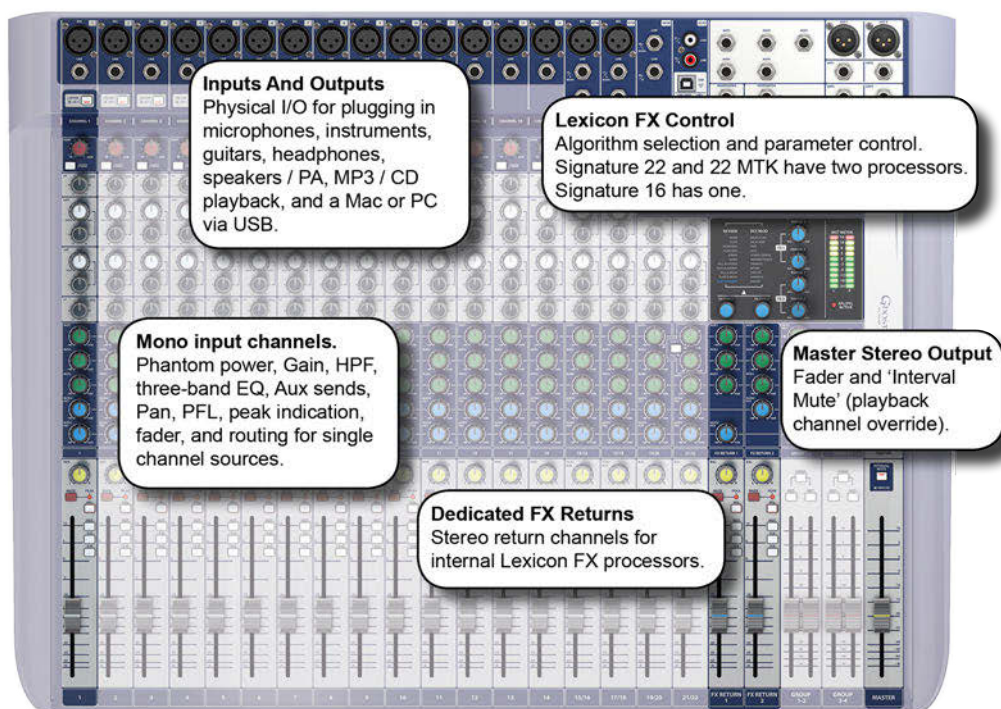

GETTING STARTED > PARTS OF THE CONSOLE

Inputs & Outputs



The Signature console features a variety of physical inputs and outputs for getting audio in and out of the console: XLR, Jack, and Phono for analogue audio I/O, and USB for digital audio. Refer to Section 3.0 for more detail, and to section 7.0 for detailed information on USB functionality. Note - USB functionality for MTK (Signature 22MTK) and non-MTK (Signature 16 and 22) are different; both types are detailed in section 7.0.

Mono Input Channels



Mono input channels control the levels, routing, and EQ on single channel audio inputs. All mono input channels have both microphone and line-level capability. In addition, specific channels feature Hi-Z inputs for high impedance sources such as guitar pick-ups. Refer to Sections 4.2 and 5.2 for more detail.

Stereo Input Channels



Signature 16, 22, and 22MTK consoles have two types of stereo inputs. One offers the option of a mono microphone/line level input by using either the XLR or Left/Mono Jack Input as well as stereo Jack inputs; the other (highest-numbered stereo channel) offers stereo line level phono inputs and is the 'Playback Channel'; the Master channel's INTERVAL MUTE function mutes all channels except the Stereo playback channel. Refer to Sections 4.3 and 5.3 for more detail.

FX Return



A Signature FX Return channel takes its input from the output of the internal Lexicon FX processor. It is a stereo input channel with aux sends but without input level control or EQ. Refer to Sections 4.4 and 5.4 for more detail.

GETTING STARTED > PARTS OF THE CONSOLE

Aux Output Masters

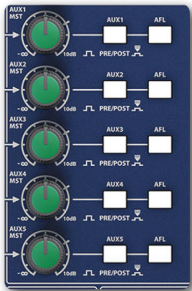

Aux (Auxiliary) Master output channels control the output level of the auxiliary bus and global pre-fade/post-fader switching. AFL switching allows aux master solos. Refer to Sections 4.5 and 5.5 for more detail.

Group Output Masters

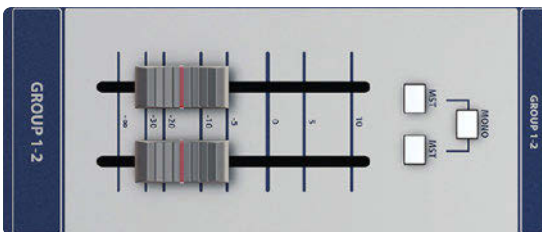

The Group Output Master channels control routing and output level for the Group busses. Groups 1 and 2, and 3 and 4 outputs can be summed to mono and/or routed to the Master Stereo Output. Refer to Sections 4.6 and 5.6 for more detail.

Master Stereo Output



Controls the output level of the Master Stereo bus. Includes the Interval Mute function (Mute all channels except the Stereo Playback Channel). Refer to Sections 4.7 and 5.7 for more detail.

Metering

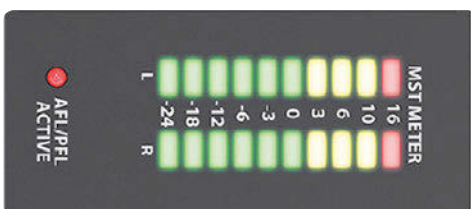

The meters show the monitoring selection level - Master Left/Right output level in normal operation or the solo bus when a PFL or AFL is engaged. The AFL/PFL ACTIVE indicator is below the main meters and lights when any AFI or PFL selection is engaged. See section 6.0 for more detail.

GETTING STARTED > PARTS OF THE CONSOLE

Lexicon FX Control



Signature 16 has a single internal Lexicon FX processor and send/return bus for adding FX such as reverb, delay, Chorus, Rotary, LoFi, Tape emulation, and more. Signature 22 and 22MTK have dual processors and send/return paths. Each Effect has two adjustable parameters. Refer to section 8.0 for more detail.

Power Indicator



Lights Green when console is powered. Use the power switch on the rear underside of the console to power it on and off. It is good practise to turn the output level down first in case this affects any connected speakers.

USB Power Socket



For attaching powered/chargeable USB peripherals such as a USB-powered LED lamp, or a mobile phone. Not for data. There is a 500mA current limit on this connection.

Global Phantom Power Switch



Applies 48V phantom power to the console microphone inputs so you can use Condenser/Capacitor microphones, active DI boxes, and so on. See section 5.1 for more detail.

Headphones Level Control



Level control for the monitoring output - either the Master Stereo Output, or the Solo Bus. See section 6.0 for more detail.

INPUTS AND OUTPUTS

The physical inputs and outputs on the Signature console are varied, and together with the Ghost mic preamps, dbx® limiting, and Hi-Z inputs provide a flexible scheme for any sources you might encounter. To get the most out of the Signature I/O, read this chapter carefully.

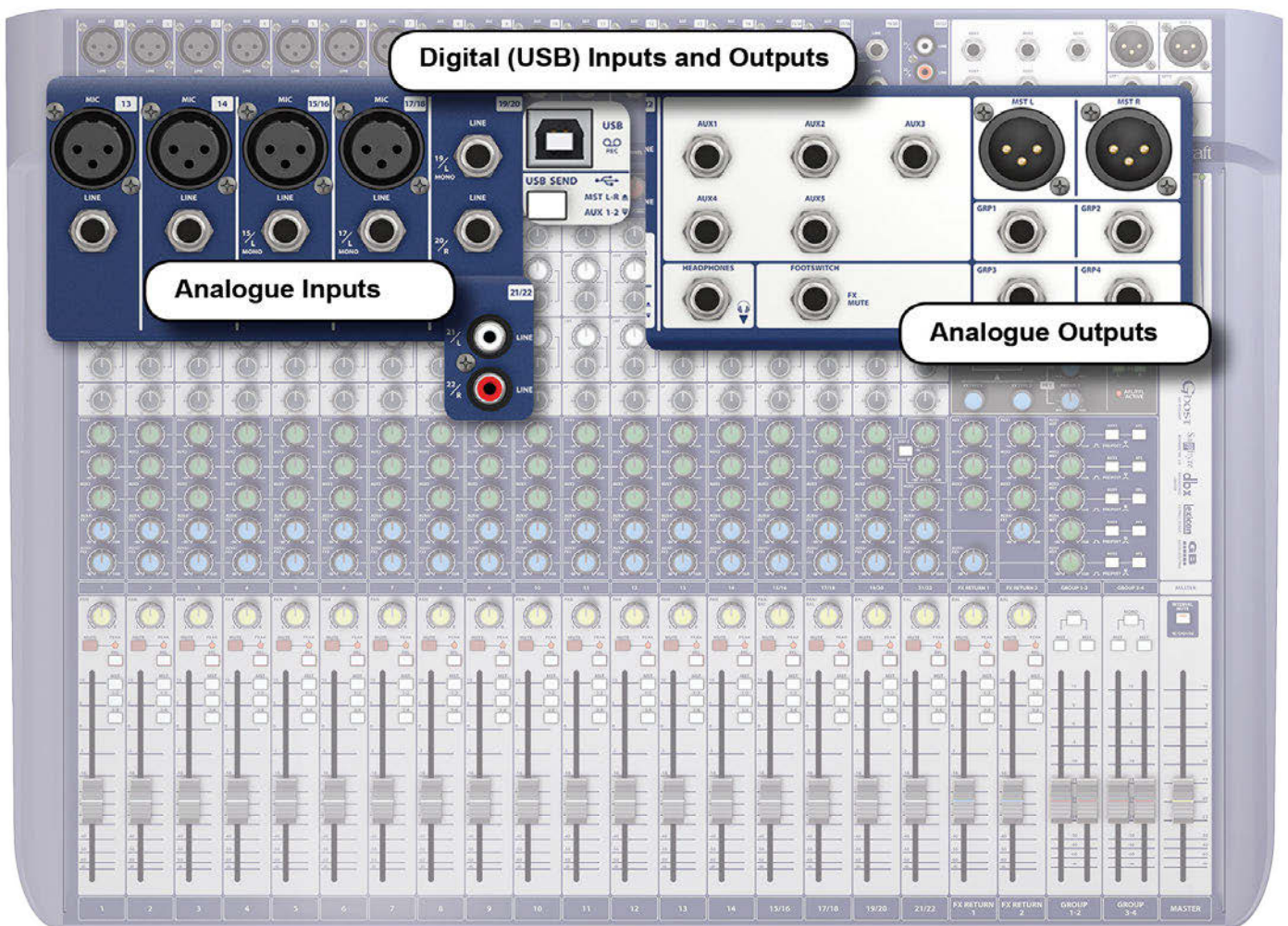

INPUTS & OUTPUTS > INTRODUCTION TO I/O

The Signature console offers a choice of industry standard audio inputs and outputs. All Jack and XLR inputs are balanced. Below are some terms used in this manual and on the console labelling that may be of use to you.

AUX (Auxiliary) Output

An output bus made up of the summed Aux contributions from input channels. In other words, the AUX1 output will be a mix of all input channel signals, with levels controlled by the AUX1 controls on the individual input channels. Auxiliary mixes are used for many purposes - alternative mixes for monitoring, processing by external FX units, and more.

Balanced

A 'Balanced' signal (Balanced Line) is one where the signal is split between two conductors with the same impedance / impedance to ground. At a differential input, the differences between the two conductors are amplified, so any noise acquired between output and input is rejected (common-mode rejection).

GRP (Group)

An output bus made up of the summed contributions from any inputs routed to the Group. For example, all inputs with their 1-2 buttons pressed will be added to the GRP1 and GRP2 mixes. The pan / balance control determines how the signal is proportioned between the Group 1 and Group 2 busses (Group 1 left, and Group 2 right).

Hi-Z

High Impedance. Guitar pick-ups generally have 'high impedance' outputs and therefore require a significantly higher than usual input impedance when plugging them directly into a console (straight from the guitar plug - not via an amp or a microphone). Hi-Z Inputs provide this. On the Signature console selected inputs have Hi-Z input switches to accommodate Hi-Z sources.

Jack

This is the long, quarter-inch connection most commonly used on the signature console for line level inputs and outputs such as keyboards, external FX processors, playback and recording devices, and so on. All Signature-series Jack sockets are 'Tip-Ring-Sleeve' 3-pole types. Jack outputs are impedance balanced.

Line

For inputs and outputs this refers to a line level signal. This is a higher voltage signal than 'mic level'.

Mic

Microphone. For inputs and outputs this refers to a mic level input. This is a lower voltage signal than 'line level'.

MST (Master)

Master Stereo Output: The main stereo Group output made up of the summed contributions from any inputs routed to 'MST' with their 'MST' buttons.

RCA

The small line-level connector commonly found on consumer playback equipment. RCA inputs are provided for the 15/16 (Signature 16) and 21/22 (Signature 22 / 22MTK) stereo input channels (Playback Channels).

USB - Universal Serial Bus

Standard serial data connection used by the Signature console for sending and receiving digital audio streams.

XLR

The round, three-pin connections. On the Signature console they are used for microphone inputs and the main stereo outputs.

INPUTS & OUTPUTS > CONSOLE INPUTS

Console inputs can be used for a wide variety of sources. For best results always use the appropriate input connection.



Mic Input - XLR

Input connection for microphones using standard XLR connection (Pin-2 hot)

When using condenser microphones, you can switch on 48V phantom power for these connections on the right hand side of the console (the 48V button). It's best practise not to use phantom power with unbalanced or instrument inputs, switching it off BEFORE unplugging and switching it on AFTER plugging in.



Line Input - Jack

Balanced line-level connection for all other inputs

A Hi-Z option is provided on selected channels, required by high output impedance sources, such as guitar pick-ups (when connecting a guitar directly to the mixer).



Line Input - RCA

Unbalanced input for line level/consumer playback equipment and instruments

INPUTS & OUTPUTS > CONSOLE OUTPUTS

The console outputs offer a range of connection options depending on the application. Always consider carefully the best output and routing strategy for your particular application.

**MST L / MST R**

Master Left and Right outputs, XLR connectors

These are impedance-balanced line level outputs (pin 2 signal). The XLR outputs are labelled 'MST L' and 'MST R', which refers to Master Left and right outputs of the main stereo output. These should be connected to the input of your amplifier, PA system, recorder, or similar.

**AUX 1 / AUX 2 / AUX 3**

Auxiliary output connectors - quarter-inch Jack

Line level output, TRS Jack. Impedance balanced.

**HEADPHONES**

Stereo headphone output - quarter-inch TRS Jack

The headphone signal is always the Master Stereo Output unless a Solo (PFL or AFL) is activated. In that case, the headphone output is switched to the Solo Bus.

**GRP 1 / GRP 2 / GRP 3 / GRP 4**

Group 1, 2, 3, and 4 outputs - Quarter-inch Jack

Line level output, TRS Jack. Impedance balanced.

INPUTS & OUTPUTS > OTHER I/O

The console outputs offer a range of connection options depending on the application. Always consider carefully the best output and routing strategy for your particular application.



USB - Signature 16 and 22

USB data connection for audio input and output

USB input (USB channels 1 and 2) are summed with the RCA input signal on the highest-numbered stereo input channel. The USB output is taken either from the Master Stereo output (MST) or the Aux 1-2 output (according to selector switch next to USB connector). For more detail on this feature, please see section 7.



USB - Signature 22MTK (24 Track I/O)

USB data connection for audio input and output

The Signature MTK (MultiTrack) console uses the USB port to send post gain direct outputs from all input channels and optionally return those channels to the same input channel. This is, in effect, a USB insert or tape return path for all input channels. USB output channels 23 and 24 are used for the Master Stereo (MST) output. For more detail, please see section 7.



USB POWER

For attaching powered/chargeable USB peripherals

Examples include a USB-powered LED lamp, or a mobile phone. Not for data. This connection supplies USB 2.0 compliant 500mA. Devices that draw more than this amount should not be connected.



FOOTSWITCH

Connect a TRS foot switch for FX Mute functionality

Various foot switches are available, depending on the specific functionality you require. Connecting Tip and Ring ('Make') will mute the internal FX.



Power

A standard IEC60320 C14 male plug for use with a C13 female plug

Rated at 110 - 240V, 50Hz-60Hz. The Power connector is located on the underside of the Signature console.

CONSOLE ROUTING

Understanding the facilities a console offers for routing and controlling audio is an important step in learning how to operate the console most effectively.

This Section uses simple flow diagrams and short descriptions to describe the various signal paths and routing options for all channel and bus types. If you have never operated a similar console before, it is worth digesting all these options before you use the console in a critical application.

Signals generally flow through the console from an input channel, then as a mix onto a bus (Aux, Group, Stereo, Solo), and through an output master (Master Stereo Output, Group Master Output, Aux Master Output, Monitor / Headphones Output).

For more basic descriptions of the main routing functions, see section 2.1: Introduction To Consoles.

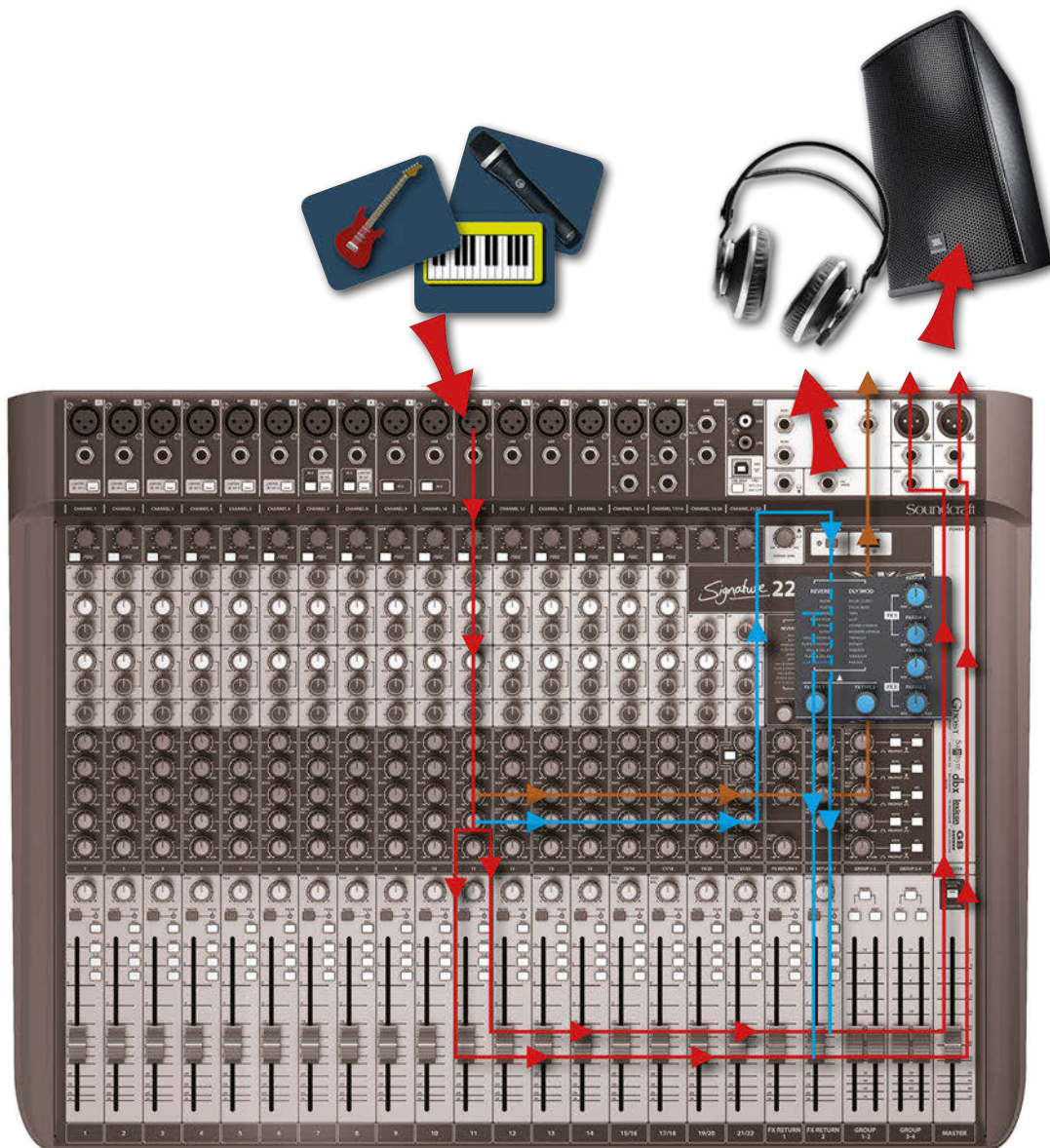

CONSOLE ROUTING > MONO INPUT

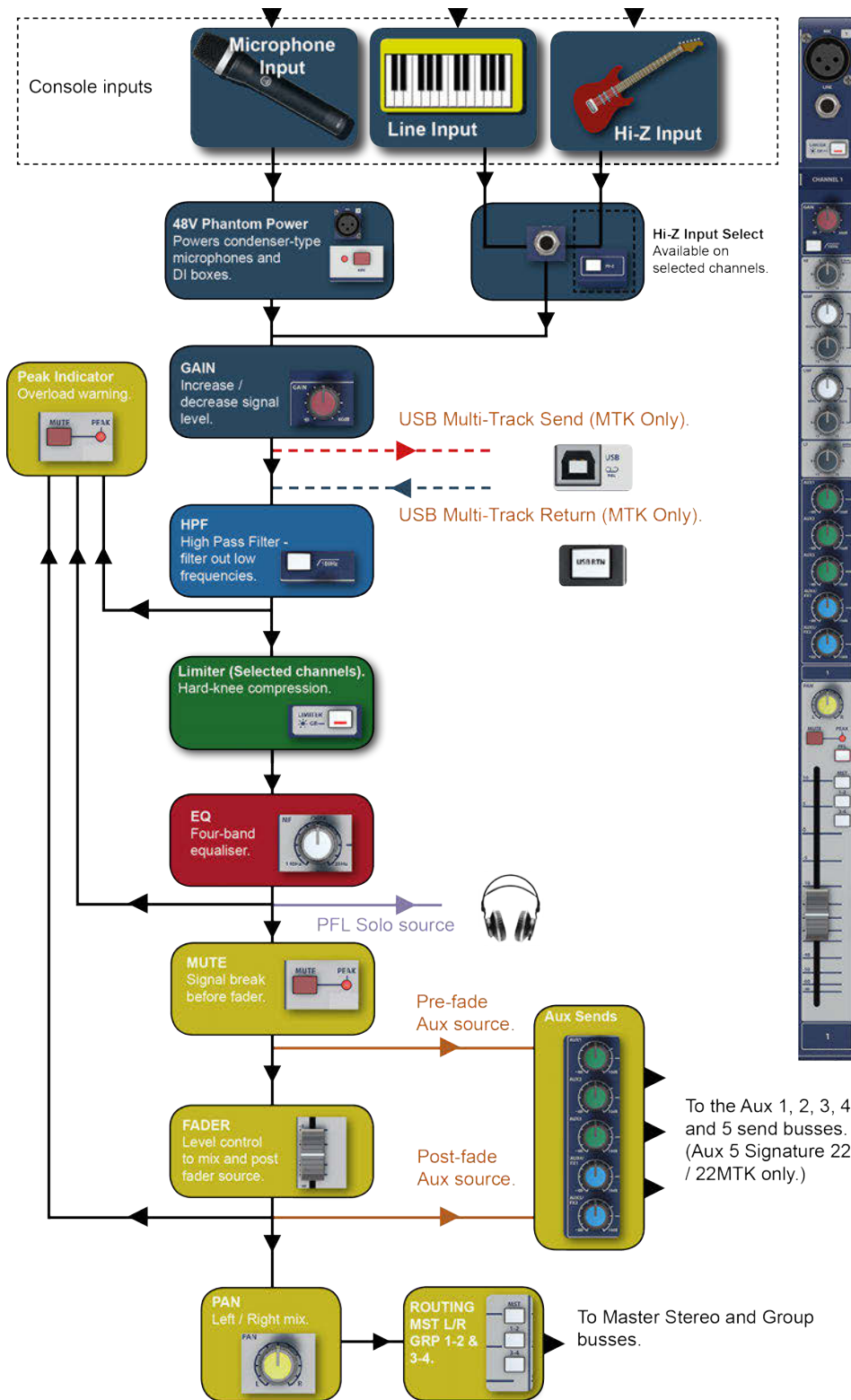

All mono input channels have the choice of XLR (mic) and Jack (Line) balanced inputs; the two highest numbered mono channels have Hi-Z input switches for the line inputs while channels 1 and 2 incorporate switchable input limiters.

All Mono input channels can contribute to Aux 1, Aux 2, Aux 3, Aux 4/FX, Aux 5/FX (on Signature 22/22MTK), MST (Master Stereo), the Solo bus, and Groups 1-4.

Like the Master Stereo bus contribution, Group contributions are sent post-pan/balance (odd-numbered groups are left, even-numbered groups are Right).

CONSOLE ROUTING > STEREO INPUT

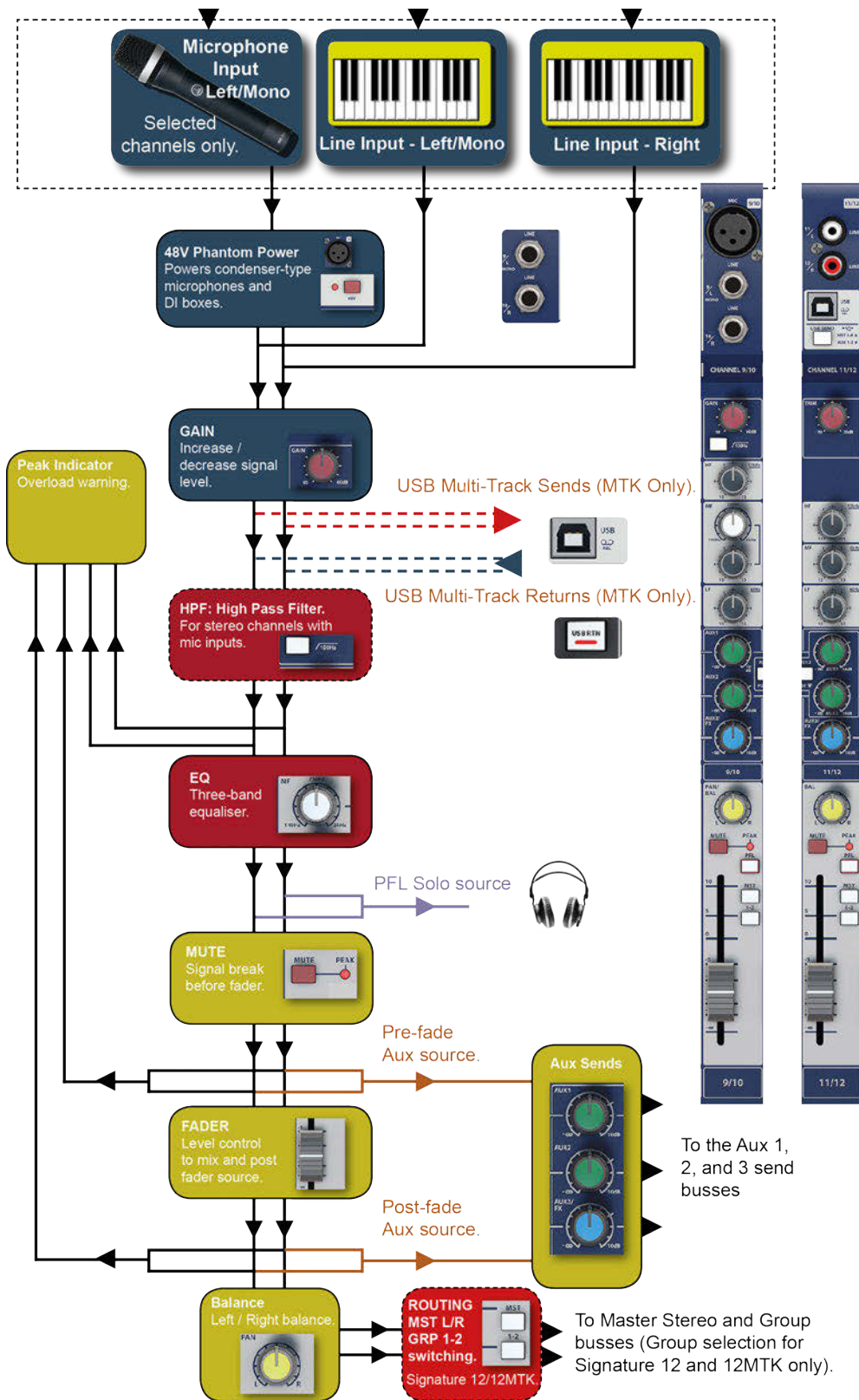

There are two types of Stereo input channel.

The lower-numbered stereo input channels have microphone inputs and Jack inputs and can be used as mono input channels (odd-numbered input) if required. On Signature 22 and 22MTK Stereo channel 19/20 doesn't have a mic input.

The highest-numbered Stereo input is a sum of the line level R inputs and the stereo USB input (if present). This is the playback channel and works with the INTERVAL MUTE function for convenient 2-track playback functionality.

Stereo input channels have the same routing options as mono input channels. Aux bus contributions from stereo channels are made from a sum of the left and right signals.

Group bus contributions are balanced / panned left and right to the corresponding odd-numbered and even-numbered group respectively. In other words - fully left would be fully Group 1 or Group 3.

CONSOLE ROUTING > FX RETURN

An FX Return channel is a special stereo input channel is fed from the output of the internal FX processor.

An FX Return channel can contribute to any Aux bus (EXCEPT its own source), and to the Master and Group busses - as per mono and stereo input channels. Signature 22 and 22MTK consoles have two FX Return channels as those consoles have two internal FX processors.

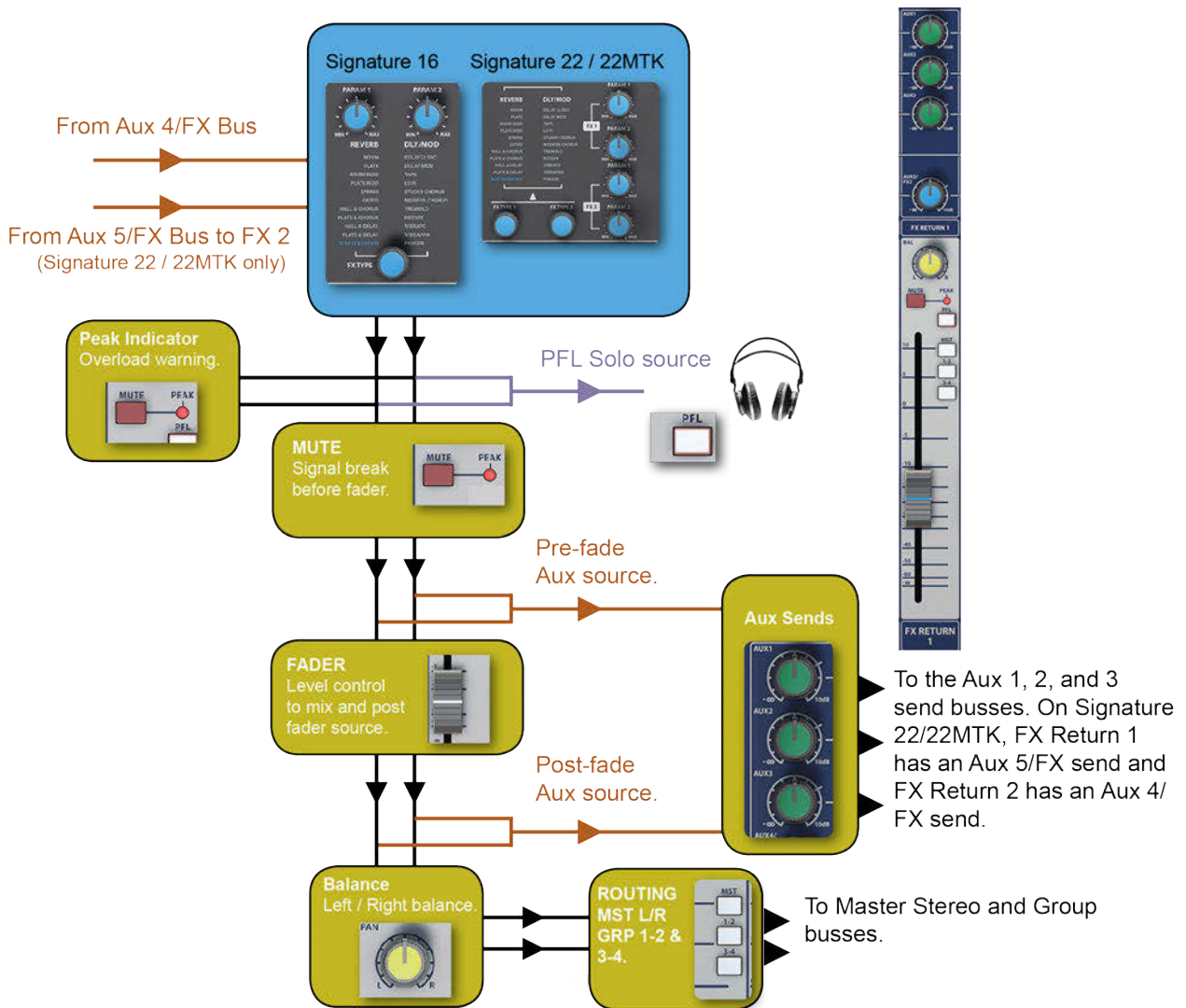

CONSOLE ROUTING > AUX MASTER

Aux busses sent directly out of the corresponding Aux outputs, and are globally switchable between pre- and post-fade sources. That is, an Aux mix that is taken 'pre-fade' (before the input channel fader) is not affected by the input channel fader levels. An Aux mix taken 'post-fade' (after the input channel fader) will be based on the fader levels of the contributing input channels.

The Playback Channel (highest-numbered stereo input) Aux 1 and 2 sends can be individually switched post-fader. This is useful where, for example, the Aux 1/2 outputs are being used for pre-fade stage monitors. By switching the 'playback' (incidental of interval music for example) to post-fader, musicians will be able to hear the playback music when it is faded up, and still allow the console operator to hear the channel on PFL without it being heard in a monitor.

Aux Masters can contribute to the Solo bus (AFL). See section 6 for more details.

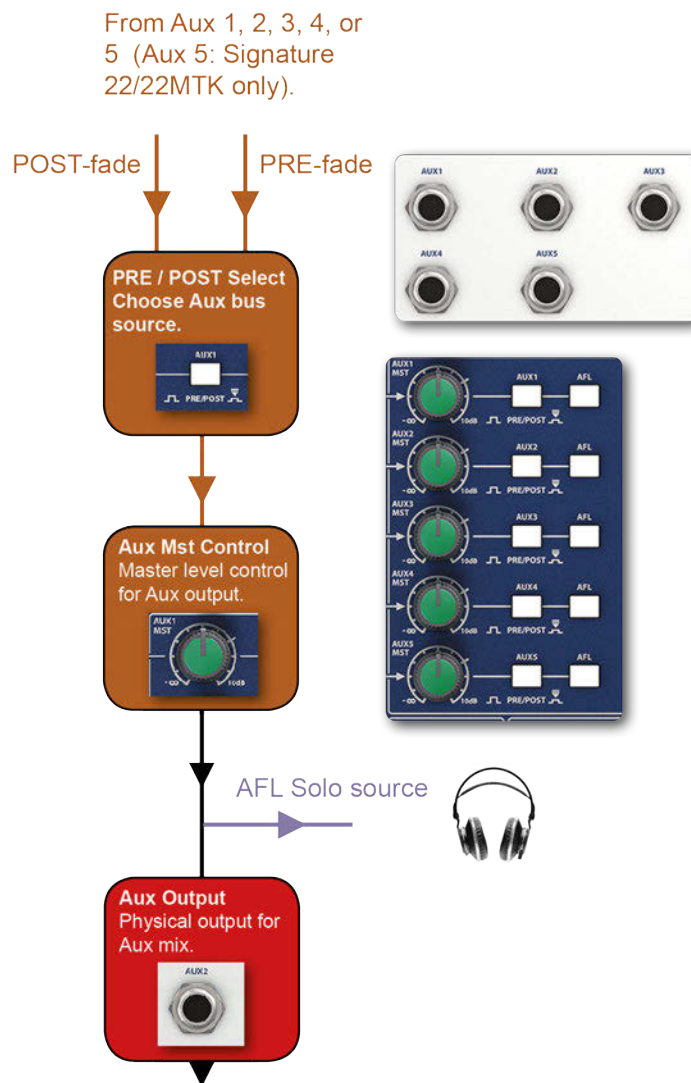

CONSOLE ROUTING > GROUP MASTER

The Group Master Outputs are derived from the post fade, post pan sum of input channels routed to the corresponding Group busses (1-2 and 3-4 switches).

The Group Masters can contribute to the Master Left/Right Bus.

A useful example of this in practise might be where a group of related input channels (drum mics, backing singers, and so on) are mixed relative to each other, then routed to GRP 1-2 (but not to MST). If the Group Masters are then in turn routed to the Master Left/Right output you can adjust the level of the whole group within the main mix by using the Group 1 and 2 faders.

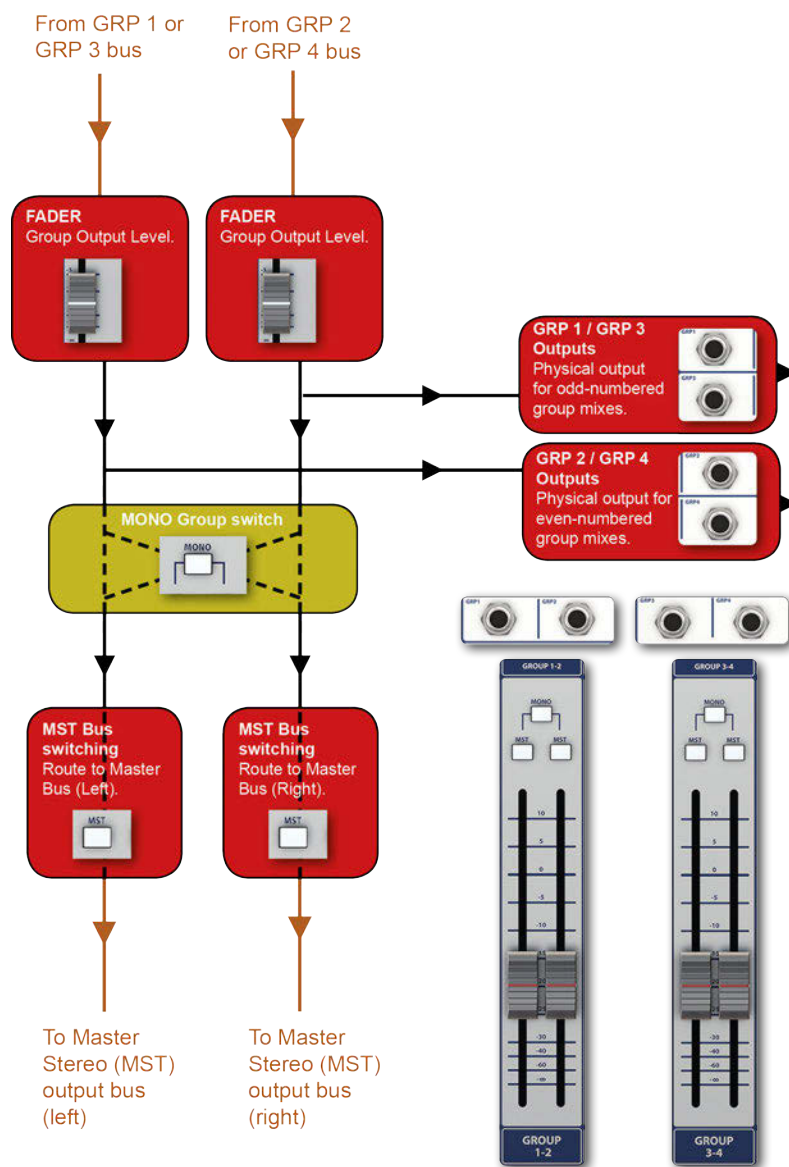

CONSOLE ROUTING > MASTER STEREO OUTPUT

The Master Stereo output is derived from contributions to the Master (MST) Stereo Bus. You can choose to route input channels to the Master Stereo Bus using the input channel MST buttons.

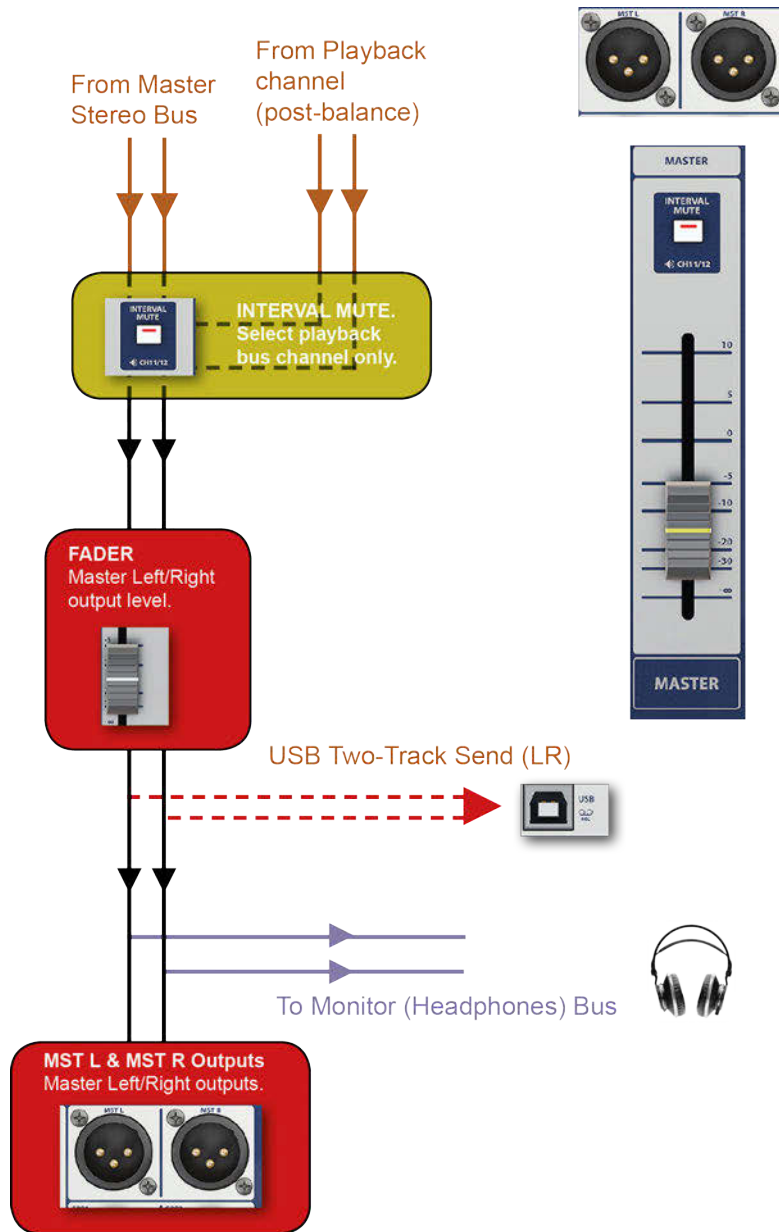

CHANNEL CONTROLS

There are three types of Signature console input channels: Mono Input, Stereo Input, and FX Return. The output channel types are the Auxiliary (Aux) Master Outputs, the Master Stereo Outputs, and the Group (GRP) Master Outputs.



CHANNEL CONTROLS > INPUT CONTROLS

Input channels take sources and route/process them. The sources catered for by the Signature consoles includes mono (single channel) sources, stereo sources, and internal sources (the FX Return channel).

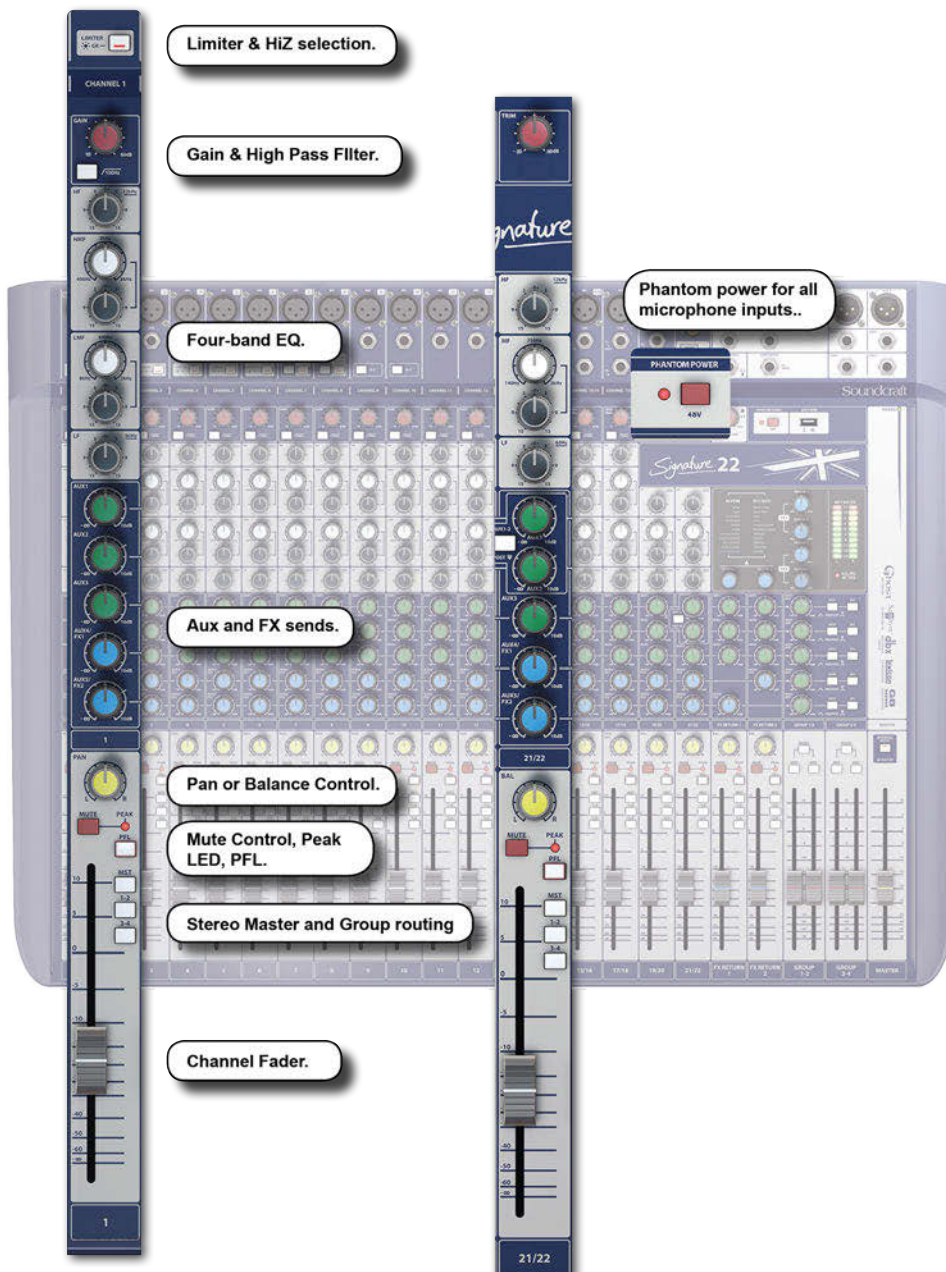

The controls are shown in the order they appear on the console channel strip - from top to bottom. This is not necessarily signal path order. Please refer to the relevant signal path diagram (section 4).

Controls common to all input channel types are documented in the Mono Input Channel controls section (5.1.1). Controls or explanations specific to Stereo input channels and the FX Return Channels are documented in those sections (5.1.2 and 5.1.3 respectively).

CHANNEL CONTROLS > MONO INPUT CONTROLS



PHANTOM POWER 48V

Apply a DC voltage of 48V to all microphone inputs

This button is found on the right of the console near the headphones level control, not on the channel strip. With phantom power on, you should use only balanced sources in the console's XLR microphone inputs. Balanced dynamic microphones (for example) will be unaffected. Condenser microphones normally require phantom power, and it is sometimes used to power active circuitry in other devices, such as DI boxes.



LIMITER

Activate the input limiter

The Signature's dbx® Limiters uses fixed time constants and threshold with high-ratio compression to tame signal peaks and prevent audio clipping. You can purposefully 'drive' the limiter by turning up the Gain until the limiter LED lights. The Limiter button LED lights when gain reduction is applied.



GAIN REDUCTION LED

Lights when the Limiter is applying gain reduction

When the Limiter applies gain reduction, the LED will light. The LED's light will become more intense as more gain reduction is applied.



HI-Z

Switch the line (Jack) input to 'Hi-Z' (high impedance) mode

Activating Hi-Z presents a much higher load impedance to the source in order to work more effectively with high-impedance sources such as guitar, bass, and other instrument pick-ups that are connected directly to the console. Using the 'standard Z' mode on high impedance sources will have a detrimental effect on the high frequency response.



GAIN

Adjust the input gain

The Gain range is -5dB to +58dB. It is advisable to listen and/or to check the channel Peak LED while increasing gain to avoid distortion due to clipping. Before plugging in a new source, turn the Gain down to avoid sudden loud noises.

CHANNEL CONTROLS > MONO INPUT CONTROLS



HPF 100Hz

Activate the High Pass Filter

The High Pass Filter (HPF) is an 18dB/Octave filter that attenuates frequencies below 100Hz. This can be useful for filtering out low 'rumble' from microphones affected by extremely low traffic noise, air flow, and so on.



USB RTN (22MTK only)

Enable the USB Return function

When active, the audio on USB channel 'n' (where 'n' is the console channel number) will replace the analogue inputs post-gain (pre HPF / EQ) and the analogue audio path will be broken. Please see section 7 for more details.



HF

Adjust the boost/attenuation of the high frequency shelving filter

The HF shelving filter has a fixed frequency of 12kHz. Frequencies above this will be boosted or attenuated depending on the control setting. With this Sapphyre asymmetric EQ, there is a small boost at the filter frequency on cut and a small cut on boost. See section 1.02 for more detail.



HMF/LMF Frequency

Adjust the centre frequencies of the High-Mid and Low-Mid bell-type filters

The Signature HMF and LMF EQ bands are bell-type, semi-parametric filters. This control adjusts the centre frequency of those bell shapes between 400Hz (approximately G3) and 8kHz (approximately B8) for the HMF Filter, and between 80Hz (approximately D#1) and 2kHz (approximately B6) for the LMF filter.



HMF/LMF Level

Adjust the boost/attenuation of the High- and Low-Mid bell-type filters

This will adjust the gain or attenuation of the audio band, centred according to the corresponding frequency controls. This is an asymmetric EQ, so boost has a wide bandwidth (low Q), and cut has a narrow bandwidth (High Q). See section 1.0.2 for more detail.



CHANNEL CONTROLS > MONO INPUT CONTROLS

**LF Level**

Adjust the boost/attenuation of the low frequency shelving filter



The LF shelving filter has a fixed frequency of 60Hz. Frequencies below this will be boosted or attenuated depending on the control setting. With this Sapphyre asymmetric EQ, there is a small boost at the filter frequency on cut and a small cut on boost. See section 1.02 for more detail.

**AUX1 / AUX2 / AUX3**

Adjust the level of this channel's contribution to the Aux 1, Aux 2, and Aux 3 busses



An Auxiliary bus is a summed 'alternate' mix of any contributing channels. In other words - for example - the console's Aux 1 output will consist of all channels whose Aux 1 controls are greater than -infinity (off) - mixed proportionally according to the relative levels of all the Aux 1 controls. You could use this for a stage monitor mix, or a 'send' to an external FX processor, for example. The source for the Auxiliary bus send can be either post-fader or pre-fade, as set by the button in the Auxiliary Masters section.

**AUX4/FX, AUX5/FX**

Adjust the level of this channel's contribution both to the Aux bus (as per Aux 1, 2, and 3), and the Internal FX processor.



Signature 22 and 22MTX consoles have two internal FX processors and therefore have an additional Aux/FX send (Aux5/FX). The Aux 4 bus and the FX bus (also Aux 5 / FX 2 busses for signature 22 / 22MTK) are independant, but share the same Send level. The source for an FX bus send is always post-fader so that a source's contribution to an effect is proportional to its contribution to the mix. The Aux source can be switched Pre or post (as per normal Aux send).

**PAN**

Adjust the signal's stereo position and group routing.



Pan determines both the signal's position on the Master (MST) Stereo output and the amount of signal sent to odd-numbered (left) and even-numbered (right) group outputs. For example, with a channel's 1-2 and MST routing switches engaged, turning the control right puts more of the signal in the right (MST) channel AND the Group 2 bus. Turning the control fully right will route the signal fully to the right-hand master channel AND the Group 2 bus.

**MUTE**

Mute the signal



This is a pre-fade mute and so does not affect the USB send on the Signature 22MTK console. However, it will mute all Aux bus contributions, as well as Master Stereo and Group contributions. When a channel is muted, the Peak & Mute LED will light.

CHANNEL CONTROLS > MONO INPUT CONTROLS



PEAK & MUTE LED

Lights when signal reaches peak level or shows that the channel is muted



The Peak LED is a warning light to let you know when the signal is nearing maximum headroom. The peak detection source is taken from a number of key points in the signal path (see section 4.1) where gain is used: After the High Pass Filter, post EQ, and post Fade. If a signal is amplified past the limits of the console's headroom, then 'clipping' (noise) will occur.



PFL

Route the signal to the Solo bus and mute any channels not routed to the Solo bus



With a PFL enabled, the headphone output will switch to the Solo Bus. Please see section 6 for more detail.



FADER

Adjust signal level



The Fader adjusts level between -infinity (no signal) to +10dB. The 0dB line indicates unity (no level change). Faders are the primary mixing tools during performance; the relative levels of the input channel faders across the console determine the Master Stereo (MST) and Group (GRP) mixes, as well as providing the source for post-fade Aux mixes.



GRP 1-2 / 3-4

Route the channel output to Group busses



The channel's PAN control determines the proportion of the signal across group pairs.



MST

Route the channel output to the Master left/right bus



The Pan/Balance controls proportion the signal to the left and right Master bus channels.

CHANNEL CONTROLS > STEREO INPUT CONTROLS

There are two types of Signature Stereo Input Channels. The normal type has two jack inputs, normalised so that a single jack or microphone input will operate as a mono input channel (Balance becomes Pan). NOTE: Controls common to all input channel types are shown in the Mono Input Channel control list - 5.1.1

**TRIM**

Adjust the input level (highest-numbered stereo channel only)



This gives a adjustment range suitable for the typical stereo line-level source for this channel, such as a consumer playback device.

**Aux 1, 2, 3, 4/FX, 5/FX.**

Adjust the level of this channel's contribution to the Aux send busses.



The Aux controls on a stereo input channel work in the same way as for a mono input channel. Please note, however - a stereo input channel's contribution to an auxiliary bus is a mono sum of the channel's left/right signals

**AUX 1-2 PRE/POST**

Switch Aux 1 and 2 sources post- fader for the Playback Channel only



The highest-numbered stereo input channel Aux 1 and 2 sends can be individually switched post-fader. This is useful where, for example, the Aux 1/2 outputs are being used for pre-fade stage monitors. By switching the 'playback' (incidental of interval music for example) to post-fader, musicians will be able to hear the playback music when it is faded up, and still allow the console operator to hear the channel on PFL without it being heard in a monitor.

**PAN/BAL**

Adjust Pan or Balance (stereo position or relative Left/right levels)



When the stereo input channel is being used as a mono input channel (no Jack in the channel's Right input), the Pan/Balance control acts as a Pan control (levels to left and right or odd/even groups proportional to the control's position), which will change the stereo position of the single source. Otherwise, the control is a Balance control, which adjusts the relative levels of the left and right signals - effectively adjusting the left-right position of the overall stereo image.

CHANNEL CONTROLS > STEREO INPUT CONTROLS



BAL

Adjust stereo balance for this channel



Adjusts the relative levels of the left and right signals for this channel, effectively adjusting the left-right position of the overall stereo image across the Master Stereo Bus and odd/even Group pairings - according to routing selections.



GRP 1-2 / 3-4

Route the channel output to Group busses



The channel's PAN/BAL or BAL control determines the proportion of the signal across group pairs.

CHANNEL CONTROLS > FX RETURN CONTROLS



A stereo FX Return channel is fed from the output of its internal FX processor. The Signature 16 has one FX Return channel and one FX processor. The Signature 22 and 22MTX have two. The FX Return channel is a cut-down version of the normal stereo channel, without trim, EQ, or an Aux send path back to its own processor's send bus (FX Return 1 does not have an Aux4/FX send).

An example in use might be running a Reverb algorithm in the processor (FX 1 for Signature 22 and 22MTX). Each individual channel's Aux 4/FX control will control how much of that source is present in the reverberant field generated by the processor; the FX return fader will then control the level of that whole reverberant field in the mixes it is routed to (Main Stereo Bus, Group 1-2, 3-4).

FX send is always post-fade so an input channel's contribution to that reverberant field will be proportional to that channel's contribution to a mix.



BAL

Adjust stereo balance for this channel



Adjusts the relative levels of the left and right signals for this channel, effectively adjusting the left-right position of the overall stereo image when routed to MST. The balance is also adjusted across group pairs when the channel is routed to groups 1-2 or 3-4.



GRP 1-2 / 3-4

Route the channel output to Group busses



The channel's PAN/BAL or BAL control determines the proportion of the signal across group pairs.

CHANNEL CONTROLS > AUX MASTER OUTPUT

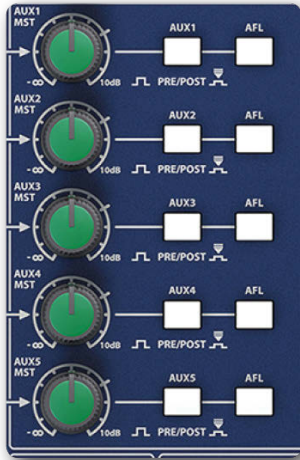

The Aux Master Output channel determines the output level of a whole Aux mix (the sum of all Aux contributions). That is, the Aux 1 Master controls the Aux 1 output level, which is the sum of all Aux 1 contributions from the input channels.



AUXn MST

Adjust the level of the Aux mix output for the corresponding Aux bus



AUXn PRE/POST

Globally switch Aux sources from input channels between pre- and post-fade

Determines whether the Aux mix is affected by the input channel fader positions or not. Note that the Stereo Playback channel has independent pre/post switching for Aux 1 and 2.



AFL

Route the signal to the Solo bus and mute any channels not routed to the Solo bus

With an AFL enabled, the headphone output source will switch to the Solo Bus. Please see section 6 for more detail.



CHANNEL CONTROLS > GROUP MASTER OUTPUT

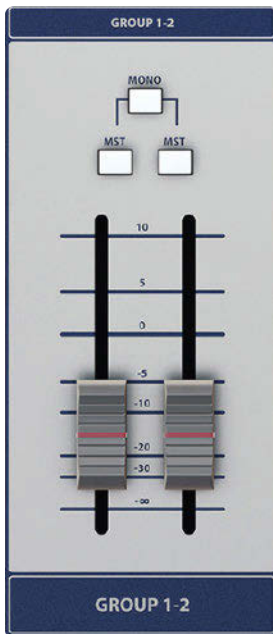

Group Masters control the Group output levels and routing.

Signature 16, 22, and 22MTK consoles have four group masters available (post-fader) - with mixes derived from any input channel routed to GRP 1-2 or 3-4. Input channel panning or balance positions work across group pairs - odd-numbered groups are left (1, 3) and even-numbered groups are right (2, 4).



MONO

Switch both Group-to-MST outputs to mono



Where a Group is routed to the Master left/right output, that contribution is derived from the sum of both Group busses. The physical Group outputs remain separate.



MST

Route the Group output to the Master Stereo mix in addition to the physical Group Outputs



Groups 1 and 3 go to the Left and Groups 2 and 4 Go to the right unless the Group Master MONO button is pressed.



FADER

Adjust the overall output level of the Group



Each group has its own fader for overall level control.

CHANNEL CONTROLS > MASTER STEREO OUTPUT

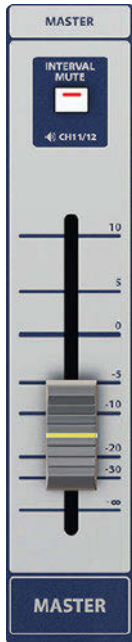

The Master (MST) Stereo Output channel determines the output level of the main stereo (left and right) mix from the MST L and MST R physical outputs.

Input channels must be routed to the Master Stereo Output with their MST buttons.



INTERVAL MUTE

Mute all channels except Stereo Playback channel 15/16 (Signature 16) or 21/22 (Signature 22/22MTK)



A fast way of switching to only the interval or playback source, or similar, without touching any other controls. Connect the playback device to the Stereo Playback channel (highest numbered stereo channel, RCA inputs). Engage the INTERVAL MUTE switch when required. All other channels are muted. NOTE: Aux and Group outputs are still active.



FADER

Adjust the overall level of the Master Stereo output

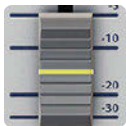

SOLO AND MONITORING

Being able to monitor sources individually is an important tool for the Mix Engineer. PFL allows you to check sources from stage without changing the mix, while AFL allows you to refine Auxiliary Monitor and FX send mixes.

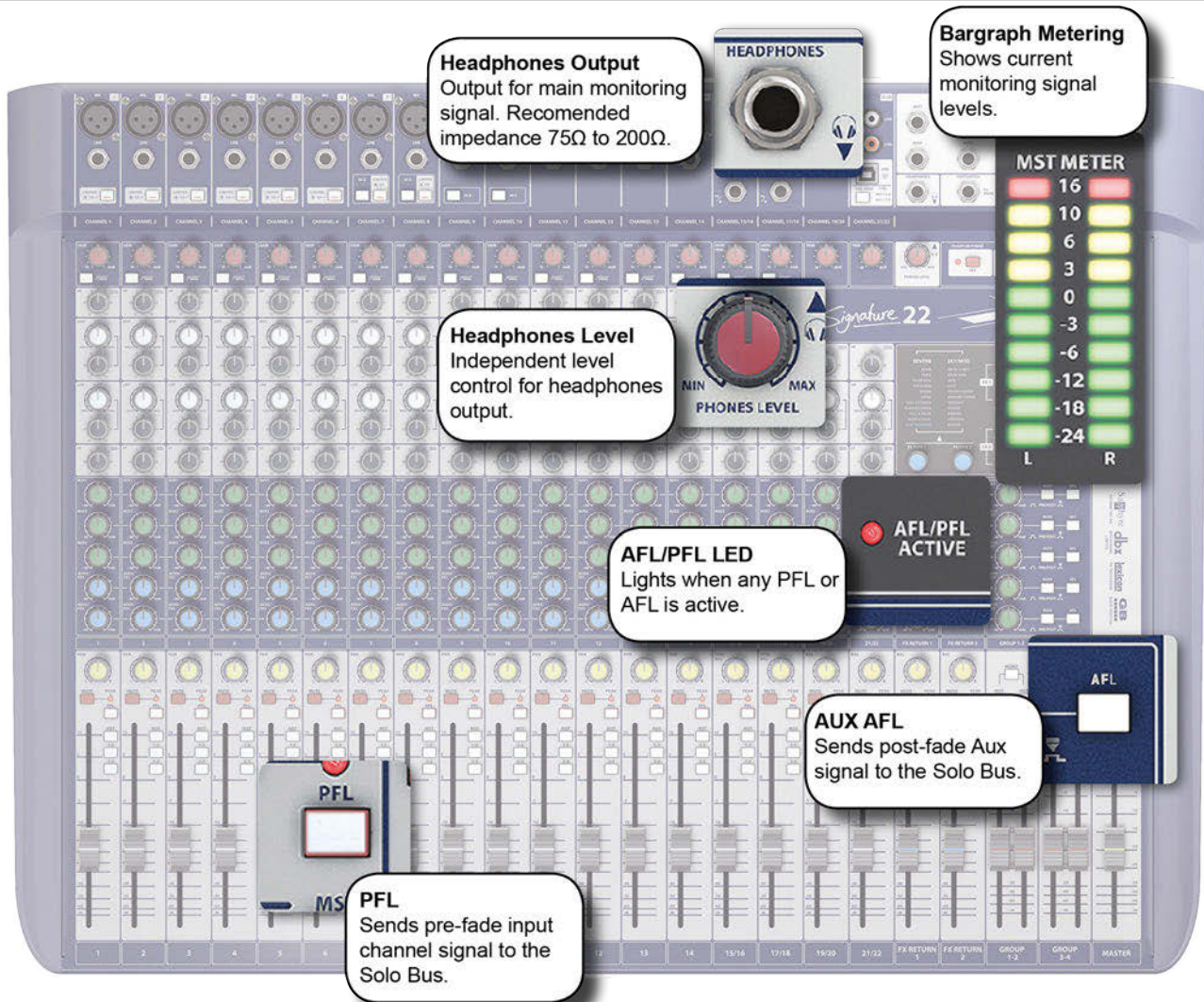

The Signature's Solo and monitoring system allows an engineer to hear either the Master (MST) stereo outputs or any channels currently assigned to the Solo bus, via the headphone output.

Pressing a PFL button on an input channel sends that source, pre-fade (pre-mute, post EQ) to the Solo Bus and switches the Headphone outputs source to the Solo bus.

Pressing an AFL button on an Aux Master output channel sends that source, post-fade (after the Aux Master level control) to the headphones.

AFL and PFL selections are cumulative. That is, pressing more than one PFL or AFL button will add that source to the Solo bus. Only when no PFL or AFL buttons are engaged will the headphone output source revert to the Master Left/Right Output (MST).

SOLO AND MONITORING



PFL

Enable the Pre-Fade Listen function



Send this input channel's signal to the Solo Bus - A pre-fade, pre-mute, post EQ signal tap. An active PFL (or AFL) switches the headphone output source to the Solo Bus. Active PFL button red indicator LEDs show active PFLs.



AFL

Switch the After-Fader Listen function



Send this Auxiliary Master output's signal to the Solo bus from a post-fade tap and switch the headphone output source to the Solo bus.



PHONES LEVEL

Adjust the level of the headphone output



The headphone output will either be the Master Stereo Output (default) or the Solo bus - if a Solo is active.



BARGRAPH METERING

Bargraph display of current monitoring (headphones) signal

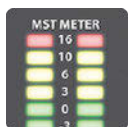

If a Solo (PFL or AFL) is active then - just like the headphone output - meters will display Solo bus levels. Otherwise they display the Master Stereo bus levels.



PFL/AFL LED

Lights when a PFL or AFL is active



Any active solo will cause this LED to light up. Leaving a Solo on is a common cause of monitoring problems. Check this LED if the monitoring output is not as expected.

USB OPERATION

The Soundcraft Signature consoles use USB 2.0 audio streaming for sending and receiving digital audio. The Signature 16 and 22 consoles have a two-track USB system while the Signature 22MTK (Multi-Track) uses a 22-channel system for channel direct inputs and outputs, plus a two-channel system for the Playback Channel and recording the recording the main LR mix.



USB > SIGNATURE 16, 22



Signature 16 and 22: 2-track USB
USB channels 1 and 2 are summed to the stereo playback channel (15/16 for Signature 16, 21/22 for Signature 22). Choose either the Master Stereo Output or Aux 1-2 for output on USB channels 1 and 2.

The Signature 16 and 22 consoles have 2-track USB input and output functionality. This could be used for recording a mix to a PC or Tablet, for example - or to use a computer as a playback device. Channels 1 and 2 are received by the Stereo Playback Channel (15/16 for Signature 16, 21/22 for Signature 22).

There are two USB Send (output) options - to send either the Master Stereo (MST) output, or the Aux 1 and 2 outputs. These are sent on USB output channels 1 and 2.



USB I/O

A USB Standard-B Plug for USB data connection



The USB connector above the highest-numbered stereo channel is for audio data connection. Please note, the USB Standard-A plug next to the PHANTOM POWER switch is for powering USB devices only (charging devices, USB-powered lamps, and so on).



USB SEND

Choose USB Send mode



When this switch is depressed, the Aux 1 and Aux 2 bus outputs will be output on USB channels 1 and 2 respectively - so that Aux 1 and 2 controls can be a dedicated USB mix. Otherwise the console outputs the Master Left and Right outputs on USB channels 1 and 2 respectively.

USB > SIGNATURE 22MTK



Signature MTK: Multi-Track USB

Input channels always send direct outs to the corresponding USB channels. USB RTN buttons activate the return for that channel so you can use it as a DAW return, insert point, or virtual soundcheck.

The Signature 22MTK console also has Multi-Track (MTK) output and input functionality that allows sending of direct outputs from the input channels and return USB audio channels directly to the input channels.

This makes it easy to set up multi-track recording and monitoring to and from a computer-based DAW, for example; or to run a virtual soundcheck from a previously recorded show.

Multi-Track channels are numbered according to Input Channel numbers, so Signature input channels 1-22 use USB audio channels 1-22.

The Signature 22MTK Input channels ALWAYS send their post-gain, pre-EQ signal to their respective USB recording channel.

The 2-track (Master Left/Right) output uses USB channels 23 and 24 and is always active.

MultiTrack USB input is selectable per-channel with the USB RTN button. When pressed, the USB input channel corresponding to the Signature channel is replaces the normal audio input for that channel (just after the USB output tap: post-gain, pre-EQ).

USB > SIGNATURE 22MTK



USB I/O

A USB Standard-B Plug for USB data connection



The USB connector above the highest-numbered stereo channel is for audio data connection. Please note, the USB Standard-A plug next to the PHANTOM POWER switch is for powering USB devices only (charging devices, USB-powered lamps, and so on).



USB RTN

Press to use the USB return-path for this channel



The USB audio channel corresponding to the input channel number will be used instead of the normal channel input. The red LED indicator on the button will light to show that the function is active.

NOTE: The analogue input to an input channel will ALWAYS be SENT via the corresponding USB audio channel, so you can use a USB SEND > DAW > USB RTN path to insert DAW-based plug-ins into the mixer's channel path.

LEXICON FX

The Signature 16 console has one internal FX processor, and the Signature 22 and 22MTK consoles have two (FX 1, FX 2) - with dedicated internal send and return routing. There are 22 different FX algorithms available, each with two adjustable parameters mapped to the PARAM 1 and PARAM 2 controls.

For FX 1, Aux 4/FX Sends control input channel contributions to both the FX processor and the Aux 4 output. For FX 2 (Signature 22 and 22MTK only), Aux 5/FX Sends control input channel contributions to both the FX 2 processor and the Aux 5 output.

An FX Return channel is a hard-wired stereo return channel for the output of the FX processor. Signature 22 and 22 MTK consoles have two FX Return channels - one for each processor.

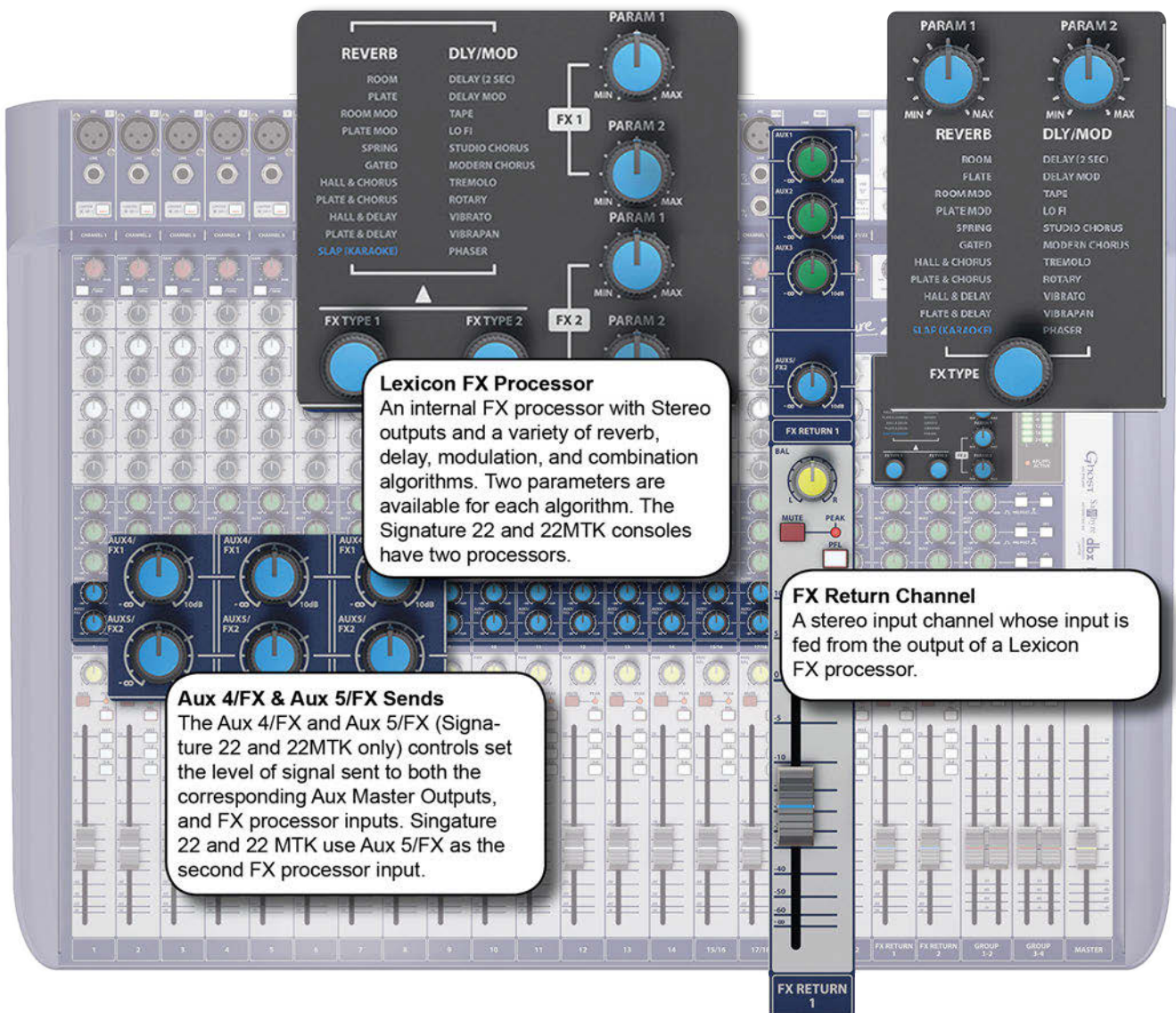

Lexicon FX Processor
An internal FX processor with Stereo outputs and a variety of reverb, delay, modulation, and combination algorithms. Two parameters are available for each algorithm. The Signature 22 and 22MTK consoles have two processors.

Aux 4/FX & Aux 5/FX Sends
The Aux 4/FX and Aux 5/FX (Signature 22 and 22MTK only) controls set the level of signal sent to both the corresponding Aux Master Outputs, and FX processor inputs. Signature 22 and 22 MTK use Aux 5/FX as the second FX processor input.

FX Return Channel
A stereo input channel whose input is fed from the output of a Lexicon FX processor.

LEXICON FX > FX CONTROL

Because an Internal FX processor has fixed routing, operation is very simple.

To use the FX, simply turn up an active input channel's Aux/FX send control; with the FX TYPE encoder select an appropriate algorithm and press the encoder to activate; push up the FX Return channel fader. You must ensure that the FX Return output routing is correctly for the application - MST / GRP 1-2 / GRP 3-4.

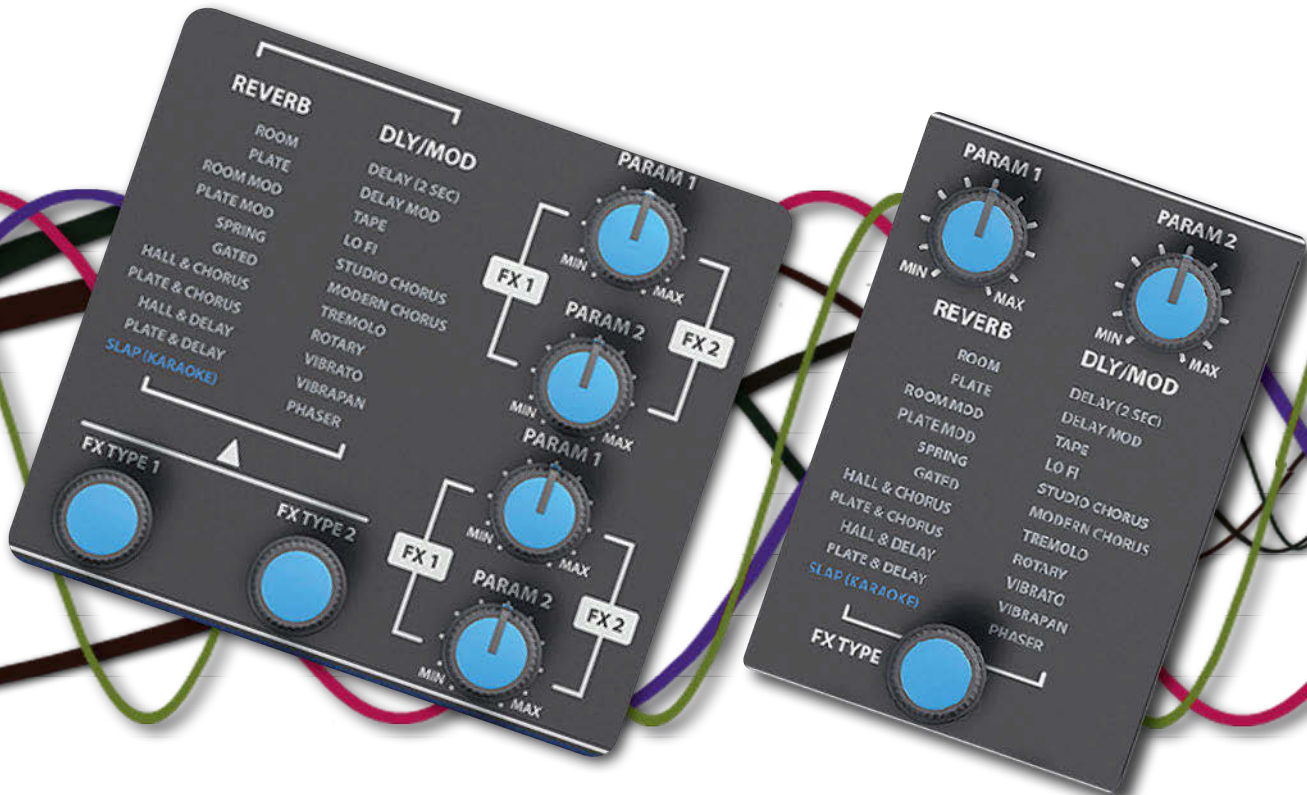

PARAM 1 / PARAM 2

Adjust FX parameters mapped to these controls



Different FX algorithms require different parameters for control. When you select a new algorithm, those parameters are assigned to the PARAM 1 and PARAM 2 controls. For a list of the parameters used for different algorithms, please see section 8.2.



FX TYPE

Select an FX algorithm (Press to activate)



The selected algorithm will be highlighted in white and loaded upon pressing the encoder. PARAM 1 and PARAM 2 encoders will be assigned to the appropriate FX parameters. Please see section 8.2 for more detailed algorithm descriptions.

LEXICON FX > REVERBS

Reverberation (or “reverb” for short) is the complex effect created by the way we perceive sound in an enclosed space. When sound waves encounter an object or boundary, they don’t just stop. Some of the sound is absorbed by the object, but most of the sound is reflected or is diffused. In an enclosed space, reverb is dependent on many features of that space, including the size, shape and the type of materials that line the walls. Even with closed eyes, a listener can easily tell the difference between a cupboard, a locker room and a large auditorium. Reverb is a natural component of the acoustic experience, and most people feel that something is missing without it.

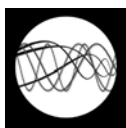
**ROOM**

Room produces an excellent simulation of a small room which is useful for speech applications. Room is also practical when used judiciously for fattening up high energy signals like electric guitar amp recordings.

Parameter 1: Liveliness
Parameter 2: Decay Time

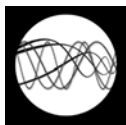
**PLATE**

The plate reverb algorithm simulates the original plate reverb effect - a large, thin sheet of metal suspended upright under tension on springs. Transducers attached to the plate transmit a signal that makes the plate vibrate, causing sounds to appear to be occurring in a large, open space. Plate reverbs are designed to be heard as part of the music, mellowing and thickening the initial sound. Plate reverbs are often used to enhance popular music, particularly percussion.

Parameter 1: Liveliness
Parameter 2: Decay Time

**ROOM MOD**

A modulated room reverb. Modulated reverbs have can have a lushness or life in the reverberation that, while artificial, can be very pleasing.

Parameter 1: Liveliness
Parameter 2: Decay Time

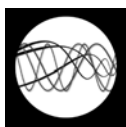
**PLATE MOD**

A modulated plate reverb. Modulated reverbs have can have a lushness or life in the reverberation that, while artificial, can be very pleasing.

Parameter 1: Liveliness
Parameter 2: Decay Time

LEXICON FX > REVERBS

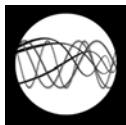

SPRING

A Spring reverb is created by a pair of piezoelectric crystals — one acting as a speaker and the other acting as a microphone — connected by a simple set of springs. The characteristic ‘boing’ of a spring is an important component of many classic rock and rockabilly guitar sounds.

Parameter 1: Liveliness

Parameter 2: Decay Time

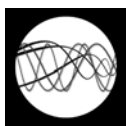

GATED

A gated reverb uses a threshold setting to abruptly cut off the reverberant field, producing a distinctive effect often used on pop percussion.

Parameter 1: Liveliness

Parameter 2: Decay Time



HALL & CHORUS

A hall reverb combined with chorus effect to thicken up the reverberant field.

Parameter 1: Decay Time

Parameter 2: Modulation Speed

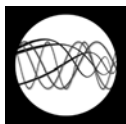

PLATE & CHORUS

A plate reverb combined with chorus effect to thicken up the reverberant field.

Parameter 1: Decay Time

Parameter 2: Modulation Speed



HALL & DELAY

A hall reverb combined with a delay effect.

Parameter 1: Decay Time

Parameter 2: Delay Time



PLATE & DELAY

A plate reverb combined with a delay effect.

Parameter 1: Decay Time

Parameter 2: Delay Time

LEXICON FX > DELAYS & MODULATION

Delays repeat a sound a short time after it first occurs. Delay becomes echo when the output is fed back into the input (feedback). This turns a single repeat into a series of repeats, each a little softer than the last.

Modulation effects use a low frequency oscillator to vary frequency, amplitude, and filter parameters over time.



SLAP (KARAOKE)

Slap echo is a distinctive vocal echo effect heard in classic Rock n Roll, Rockabilly, and other 'classic' genres, hence its popularity in Karaoke!

Parameter 1: Number Of Repeats
Parameter 2: Delay Time



DELAY (2 SEC)

Basic delay algorithm with up to two seconds delay time.

Parameter 1: Number Of Repeats
Parameter 2: Delay Time



DELAY MOD

The modulated delay is enhanced by an LFO (low frequency oscillator) that produces a chorusing effect on the delay repeats. This is a great delay for guitar and instrument passages that need that "special something."

Parameter 1: Number Of Repeats
Parameter 2: Delay Time



TAPE

In the days before digital, tape echoes were created using a special tape recorder in which the magnetic recording tape was looped, with closely-spaced recording and playback heads. The delay effect was created by the tape moving in the space between the record and playback heads – while delay time was adjusted by changing the speed of the tape loop. Although very musical-sounding, wow and flutter combined with a significant loss of high frequencies, and to some extent also low frequencies, are all elements commonly associated with tape echo.

Parameter 1: Number Of Repeats
Parameter 2: Delay Time

LEXICON FX > DELAYS & MODULATION

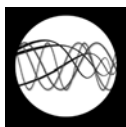

LO FI

Delay with limited bandwidth that degrades the signal in a pleasing way for a crunchy percussion or any where a lo-fidelity effect will enhance the feel.

Parameter 1: Number Of Repeats
Parameter 2: Delay Time



STUDIO CHORUS

Chorus creates a lush, full sound by combining two or more signals together where one is unaffected and the other signals vary in pitch very slightly over time. Chorus is commonly used to fatten up tracks and to add body to guitars without colouring the original tone. Chorus can also be used with discretion to thicken a vocal track. Studio Chorus is a studio-quality chorus with a wide stereo image.

Parameter 1: Modulation Speed
Parameter 2: Modulation Depth



MODERN CHORUS

Dual-voice chorusing that's both very rich and very smooth.

Parameter 1: Modulation Speed
Parameter 2: Modulation Depth

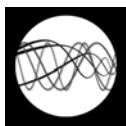

TREMOLO

A basic stereo amplitude (volume) modulation effect.

Parameter 1: Modulation Speed
Parameter 2: Modulation Depth

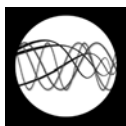

ROTARY

Rotary speaker cabinets were designed to provide a majestic vibrato/choir effect for electronic theatre and church organs. This algorithm emulates the famous Leslie™ speaker with two counter-rotating elements: a high-frequency horn and a low-frequency rotor with slow and fast speeds.

Parameter 1: Modulation Speed
Parameter 2: Modulation Depth

LEXICON FX > DELAYS & MODULATION



VIBRATO

Vibrato is obtained by smoothly modulating the pitch of the signal just sharp and flat of the original at a determined rate.

Parameter 1: Modulation Speed
Parameter 2: Modulation Depth



VIBRAPAN

A unique dual voice vibrato effect with a variable phase control for the voices.

Parameter 1: Modulation Speed
Parameter 2: Modify / Phase Control



PHASER

The Phaser automatically moves frequency notches up and down the spectrum of the signal by means of a low frequency oscillator (LFO), creating an oscillating “comb filter” type effect. This effect is very useful on keyboards (especially pad presets) and guitars.

Parameter 1: Modulation Speed
Parameter 2: Modulation Depth

NO SOUND

A Troubleshooting Guide.

Is an input failing to appear at appearing at an output? The best approach it is to first make sure the input is valid, and then work through the signal path to find out where the 'break' is... Check the exact audio path of any signal by referring to the signal path diagrams in Chapter 4.

Check Solos

If a PFL light on an input channel is lit, or the AFL/PFL ACTIVE LED (below main audio meter) then a solo is active and all channels except those that are 'soloed' will be muted. This will only affect the headphones output.

Clear all active Solos by pressing any illuminated Input Channel PFL buttons and any engaged Aux Master AFL buttons.

Check Input Channel Path To Solo Bus

The channel solo can be very useful here. If you Solo the channel it will send a post-EQ, pre-Mute signal to the Solo bus and you should be able to see signal indicated on the main meters, or hear it in the headphones.

Things that might prevent the signal getting that far include a GAIN control set too low, phantom power not switched on for a source that requires it (condenser microphone, active DI etc), or an active SUB RTN switch on a channel where there is no USB input (MTK models only).

Check the Input Channel routing diagram (Section 4.1) and ensure the channel controls are set up correctly.

Check Input Channel Path To Routing

If the signal is present on the Solo bus with PFL engaged, the problem might be further down the input channel. It could be simply that the Mute is active, or the fader is down - or there could be a problem with the routing.

For a signal to go to the Main Stereo Bus or to a Group Bus, the corresponding routing switch must be engaged (MST, 1-2, or 3-4). Also, a pan or balance control can have a significant effect - if the signal is routed to Groups 1-2, for example, and the pan control is full left (Group 1), you won't hear anything from the Group 2 bus.

Check Mute and fader status, and that the channel routing selections are correct.

Check Bus Masters

If you have routed signal to the Main Stereo bus or a Group bus, or you have turned up the channel's contribution to an Aux bus, then the master controls for that bus must be set correctly. For example, if the signal is routed to the Stereo master but the Stereo Master fader is down, you won't hear anything.

Check the controls on any Bus Masters that the signal is routed to.

No FX?

For an internal FX to be heard, there must be a source contribution from a valid input. Increase the level to the FX bus using the Aux/FX control (Aux 4/FX for Signature 16, Aux 4/FX and Aux 5/FX for Signature 22 and 22MTK. Also, the signal is return through the corresponding FX Return Channel. Troubleshoot this signal path as you would do for a normal input channel.

The internal FX routing has three stages - send, processor, and return. All three must be set correctly for the FX to be heard.